



DECOMASTER

ИНТЕРЬЕРНЫЙ ДЕКОР

The background features a complex, layered decorative frame. The outermost frame is dark with a textured, wood-like grain. Inside it is a lighter, aged gold frame with a distressed finish. The innermost frame is a thin, ornate silver border with a repeating scrollwork pattern. Behind the frames is a dark, swirling, marbled pattern in shades of brown and purple.

БАГЕТ

WWW.DECOMASTER.SU



947-565

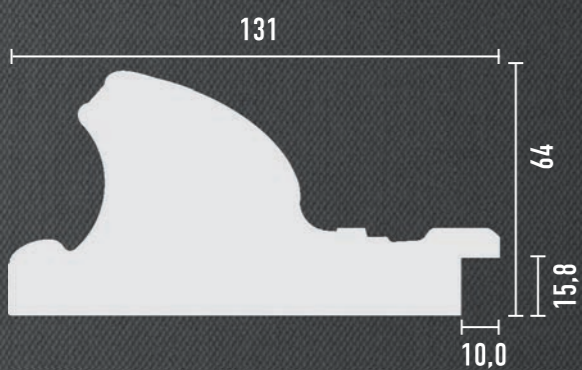

947-566



947-954



947-956



S16-1223



S16-966

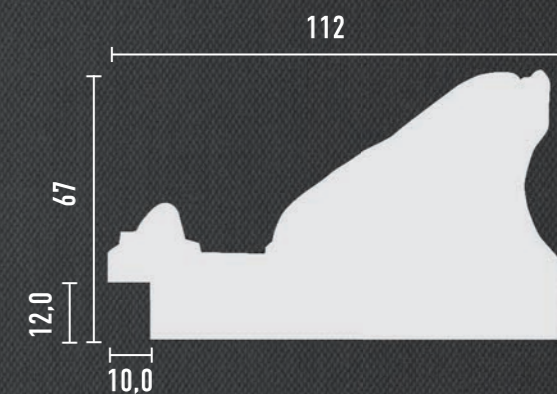



230-966



230-1223



230-1543 **NEW**



230-1604B **NEW**



230-1605B **NEW**



230-1610 **NEW**



230-70 **NEW**



980-565



980-566

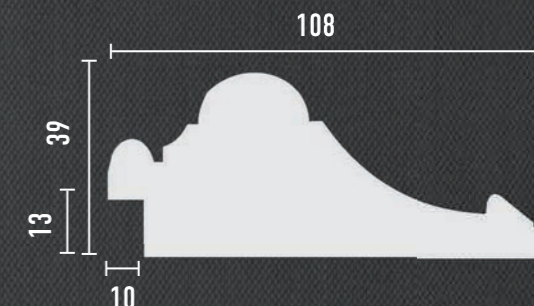



229-1223



229-966



229-645



229-955

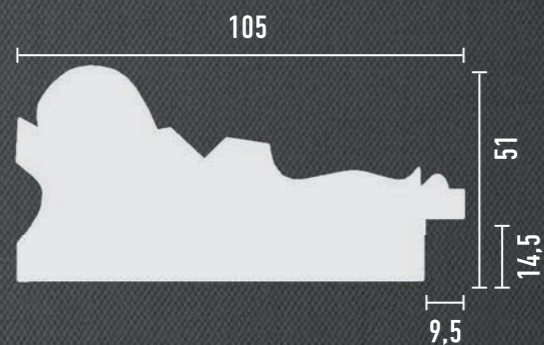

229-1068



229-182

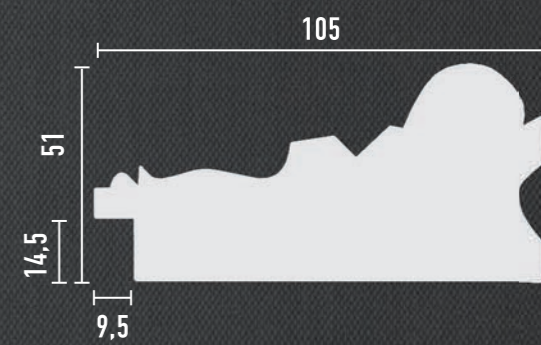



400-958



400-954



400-956

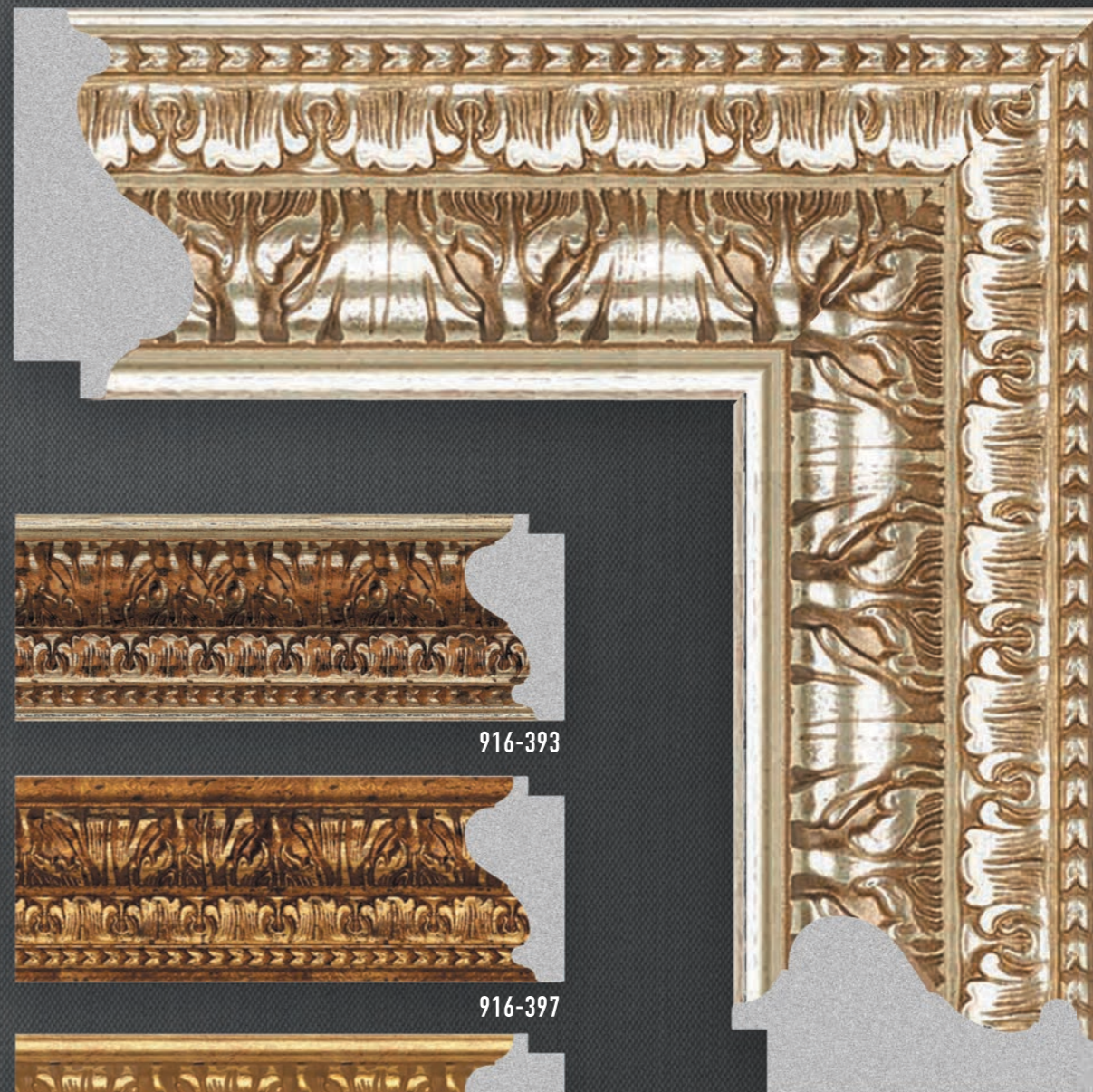
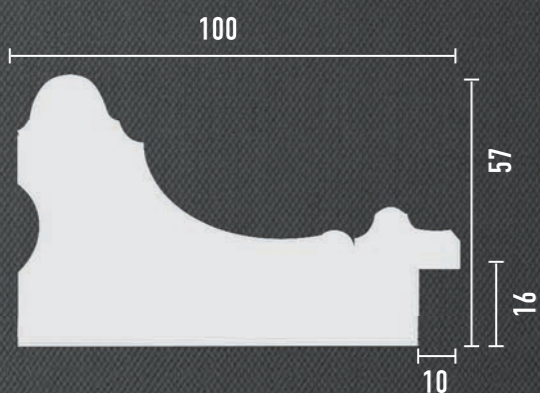

916-393



916-397



916-461

916-247

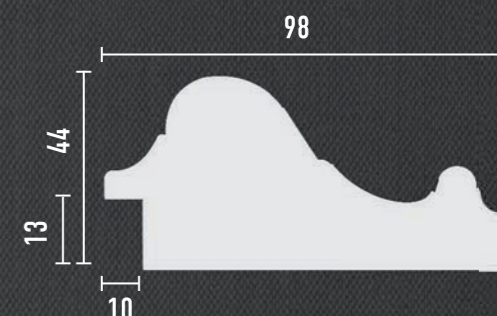



214-3

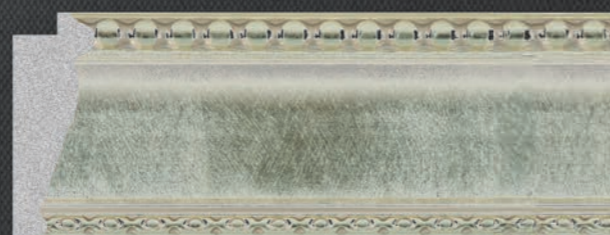

214-373



214-6

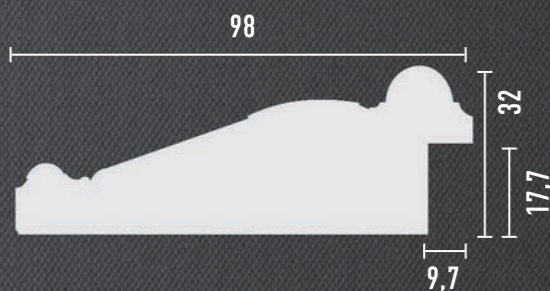

NEW S26-1604B



NEW S26-1605B



NEW S26-70





413-566



413-565



413-919

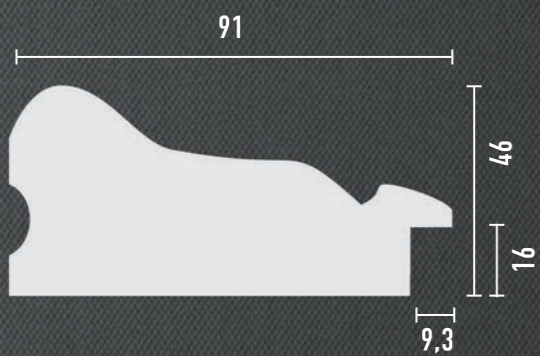

413-182



413-494

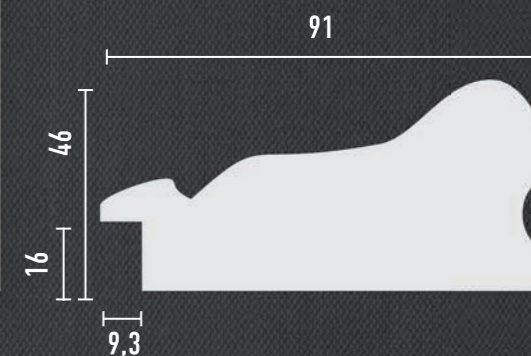



413-1606 **NEW**



NEW 413-1607



NEW 413-1608



NEW 413-1609

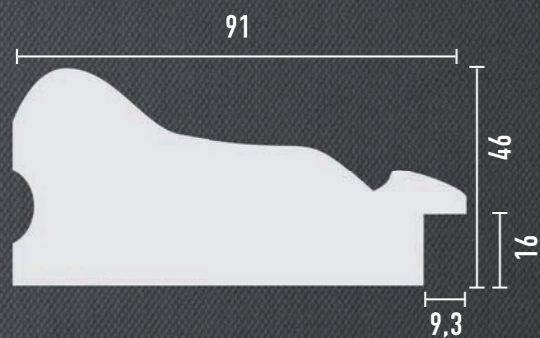

927-252

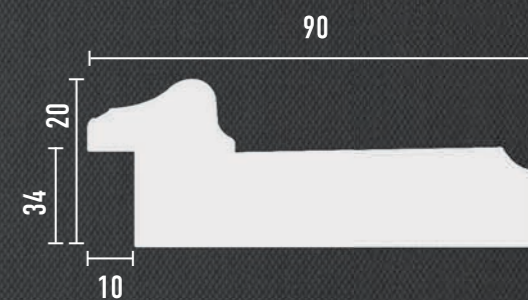



293-752

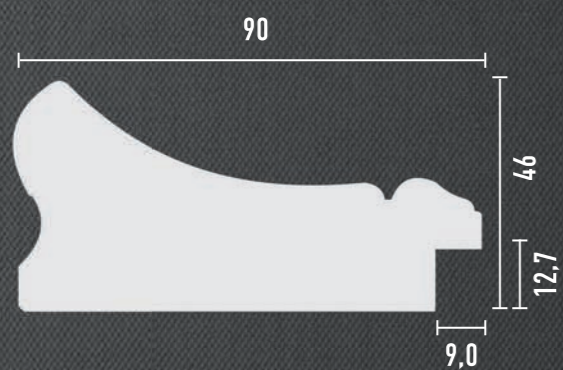

849-919

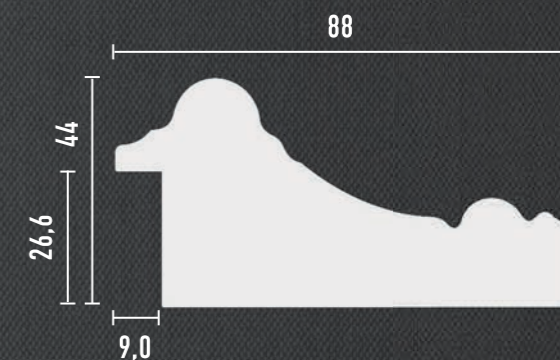



849-566



849-565



849-373

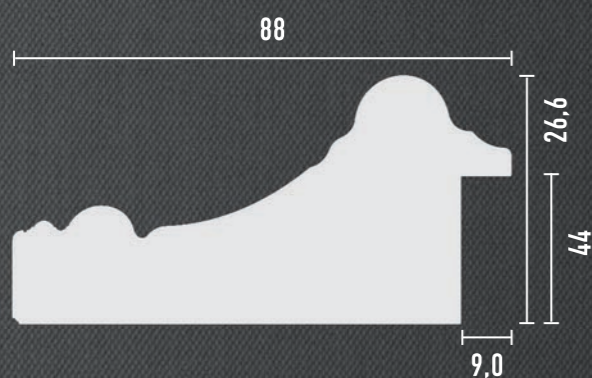

868-645

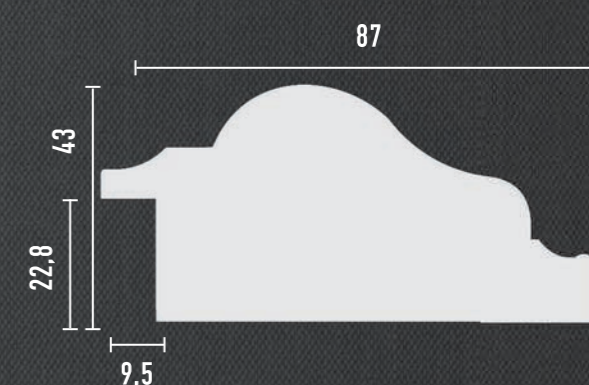



516-1069



516-1333

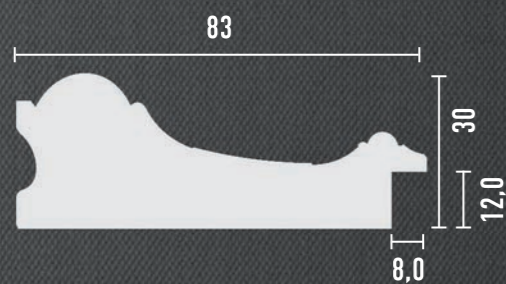

516-126



516-767



516-127



516-1070

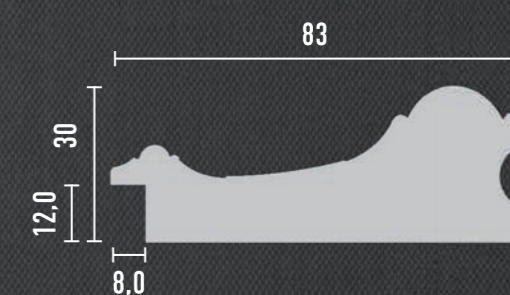

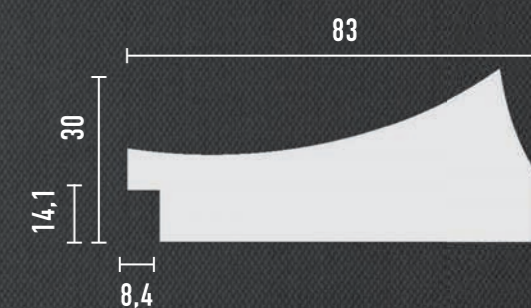
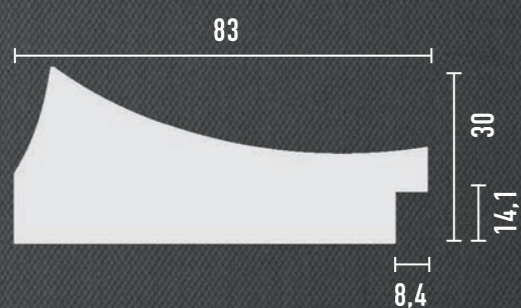

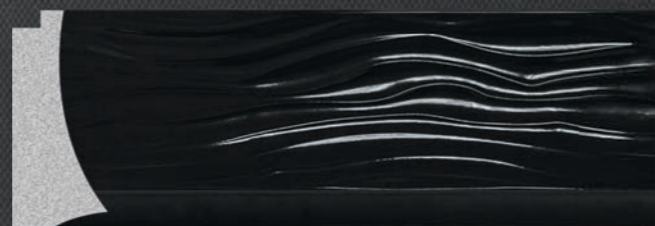

552C-195 NEW



552C-114 NEW

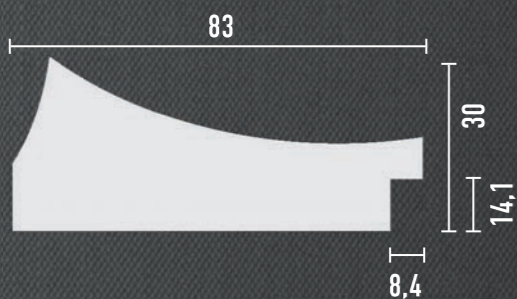

NEW 552D-114



NEW 552D-195

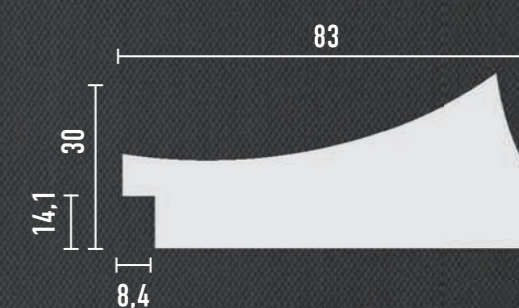



S18-966



S18-1223



S18-1224

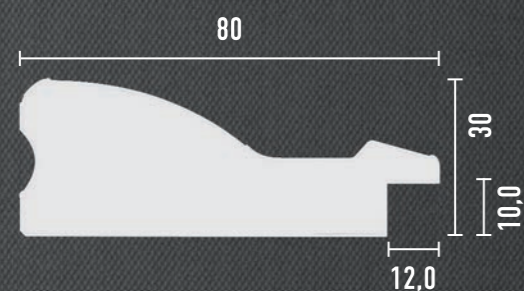

696-401



696-182

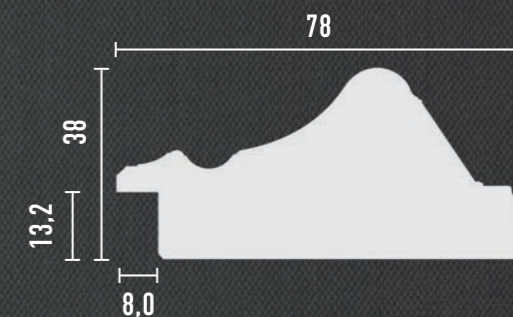

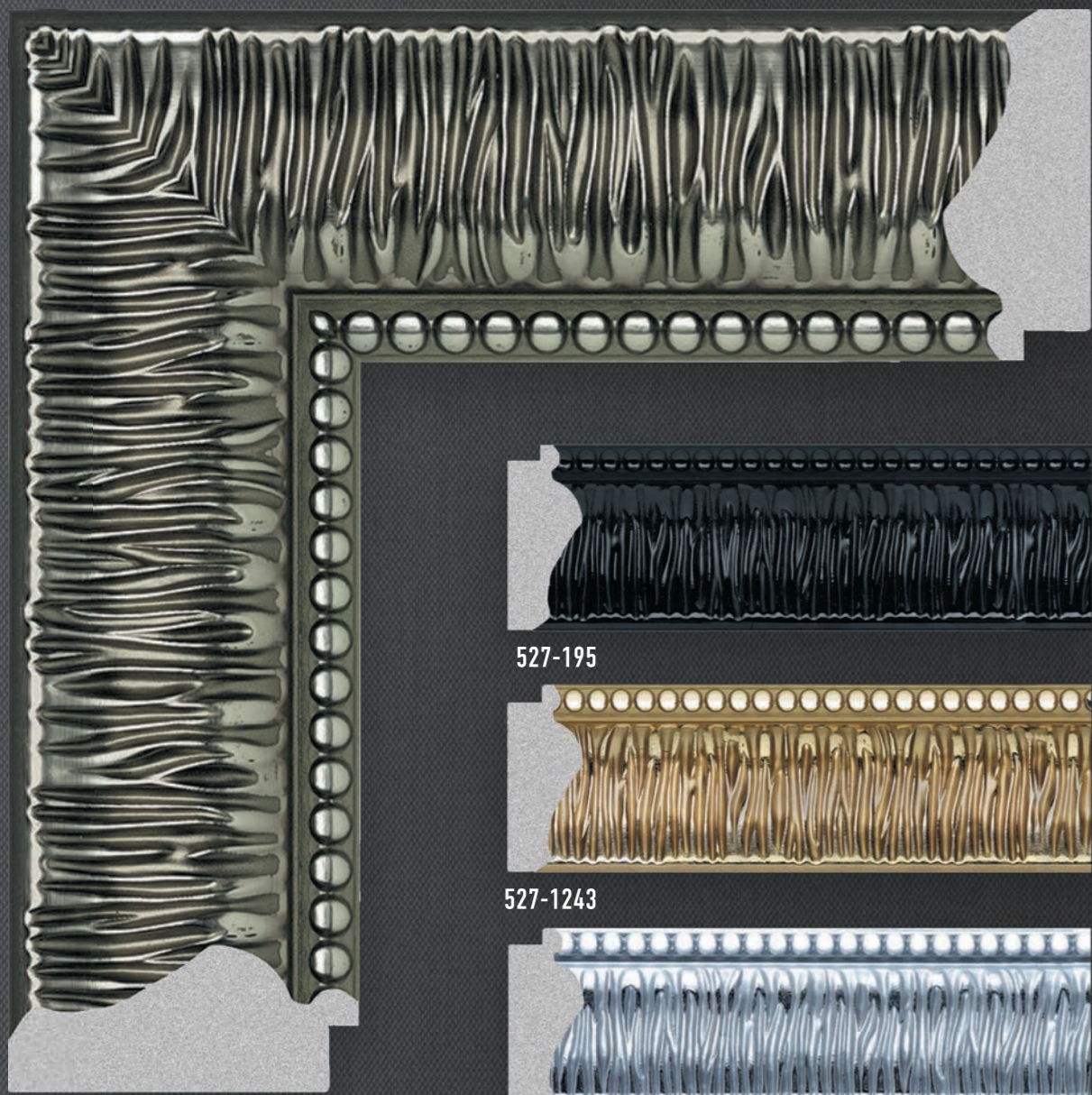

527-725



527-195

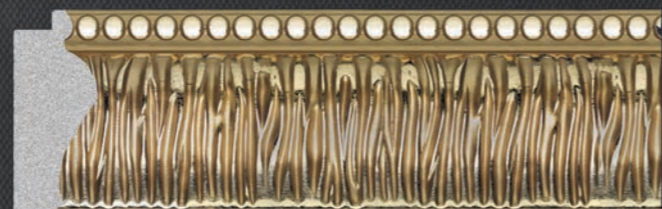

527-1243

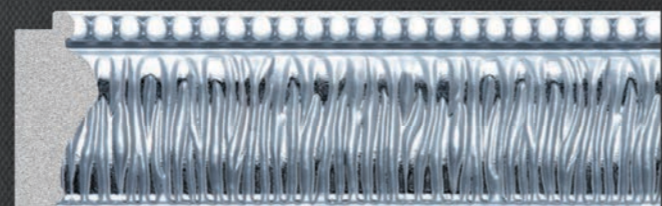

527-1244



527-114

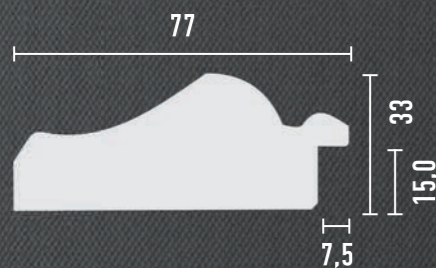

NEW 919-1604



NEW 919-1604B



NEW 919-1605



NEW 919-1605B

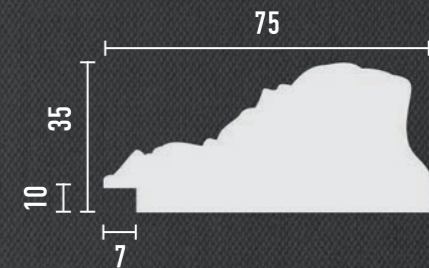

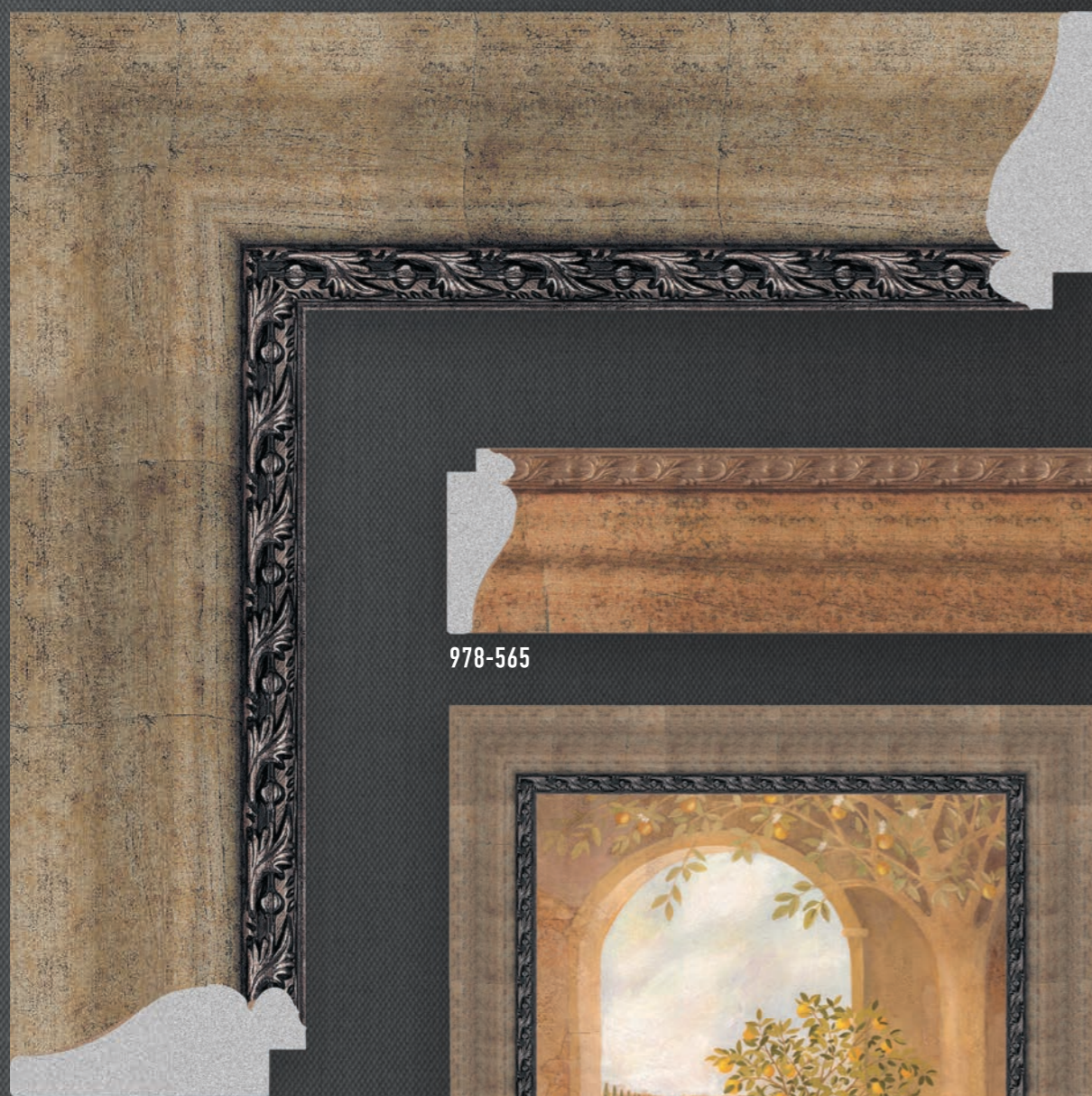

978-565



978-566

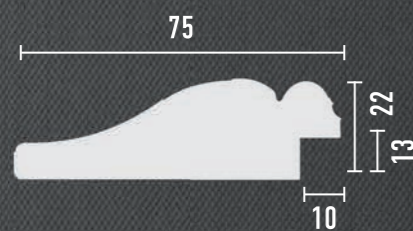

582-433



582-438



582-440



582-27

582-26

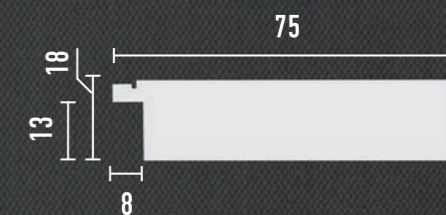



811M-905

811M-906

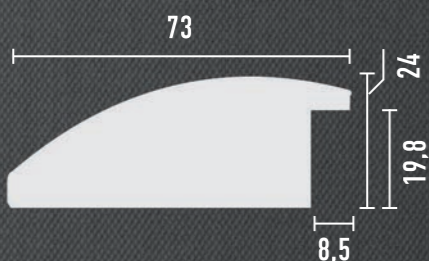
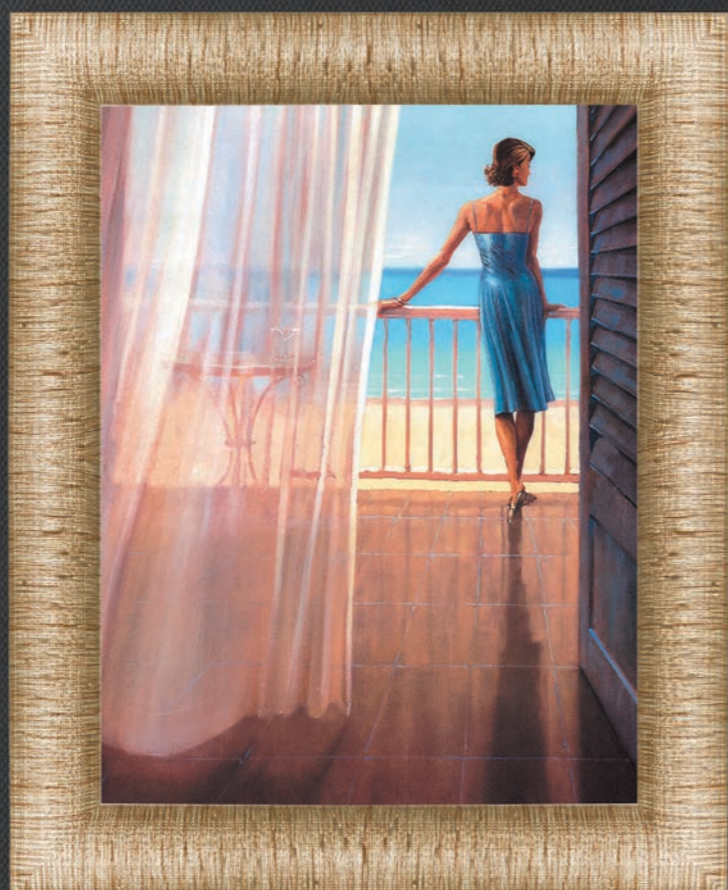

108-1333



108-1069



108-7

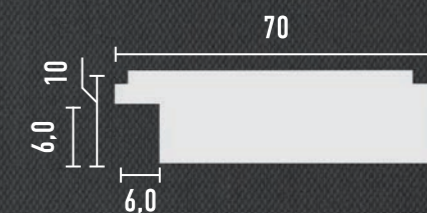

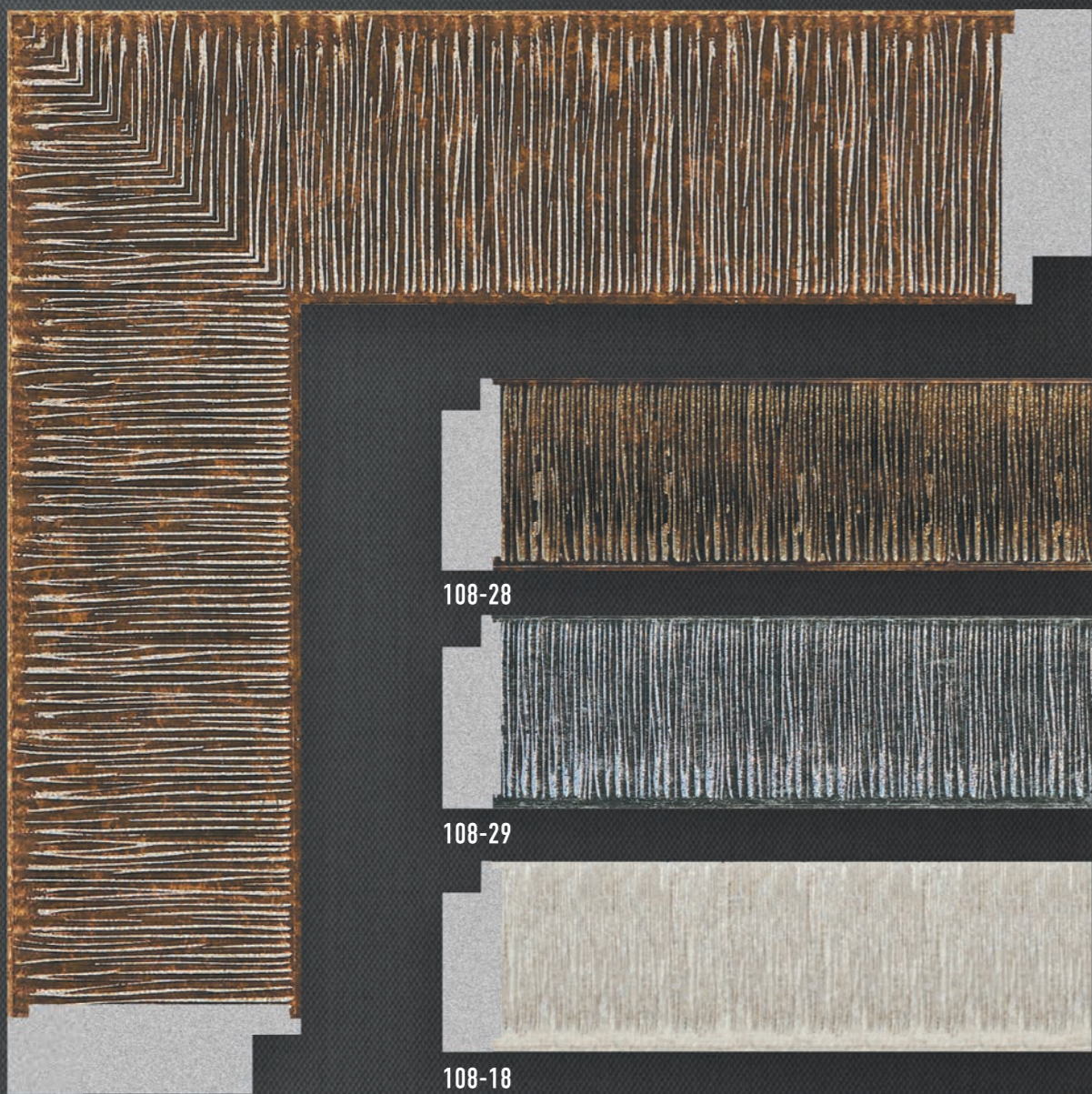

108-17



108-28

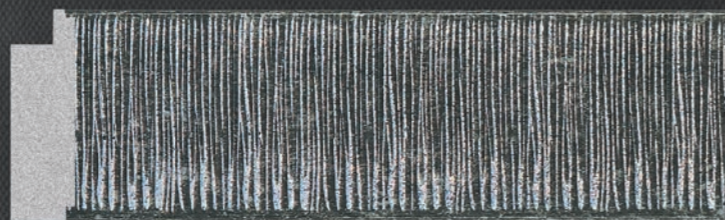

108-29



108-18



108-19



108-20

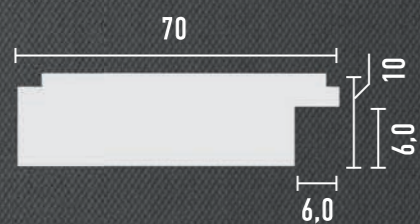

577-966



577-1223

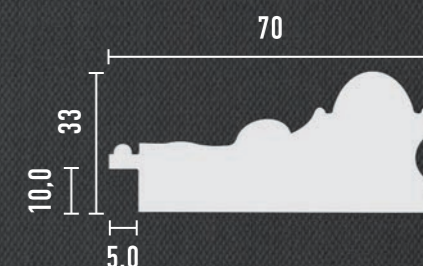



566-1223



566-1224



566-1606 **NEW**



566-1607 **NEW**



566-1608 **NEW**



566-1609 **NEW**

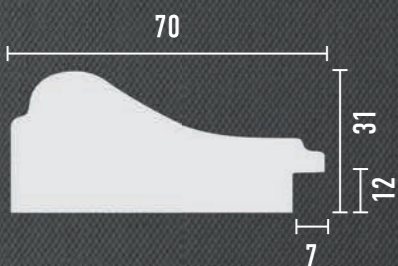

690-198



690-182

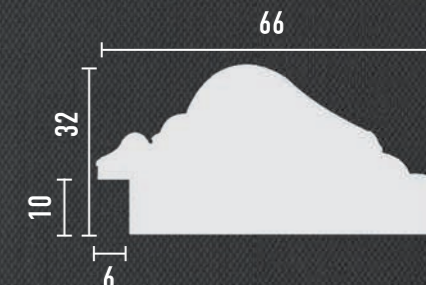

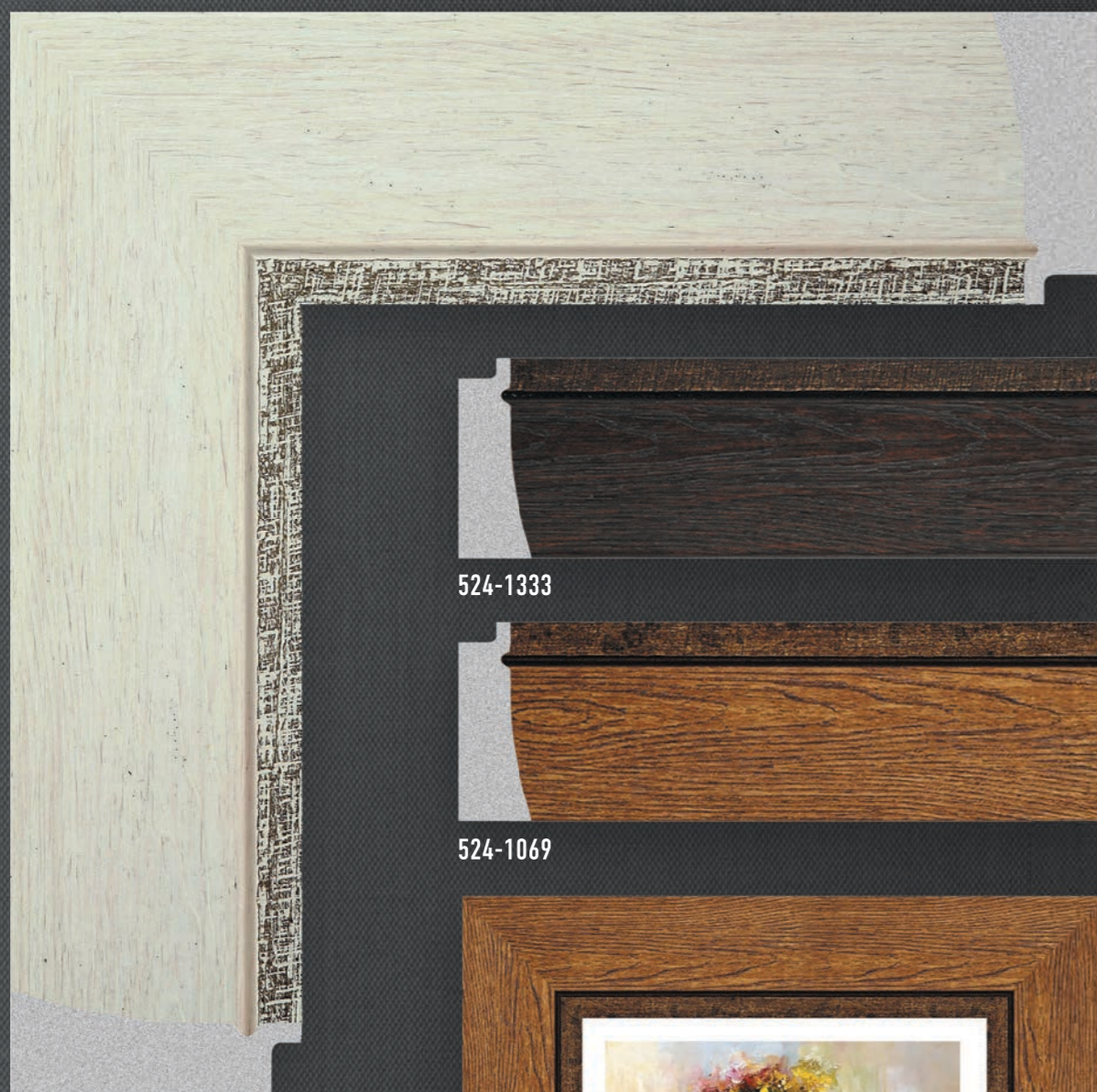

524-1070



524-1333



524-1069



176-1



176-3



176-4



176-5



176-6

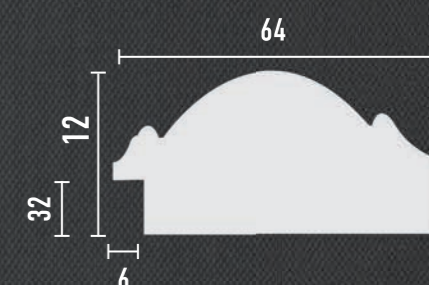

176-2



829-934



829-294



829-935

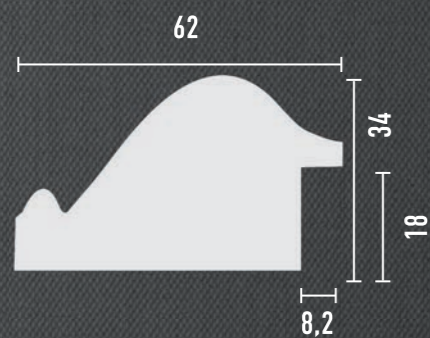

304-566



304-126



304-127





808-553



808-552



808-176S

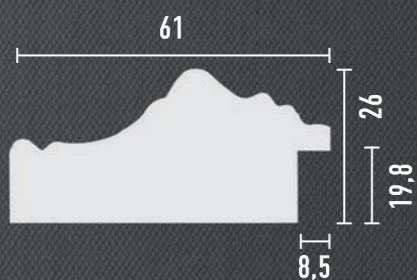

NEW 587-1604



NEW 587-1604B



NEW 587-1605



NEW 587-1605B

NEW 587-70

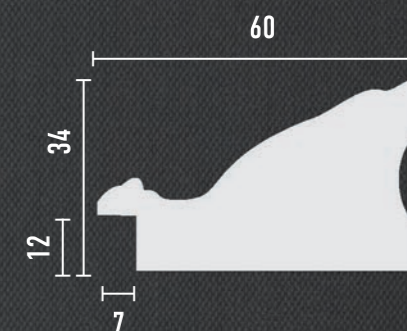

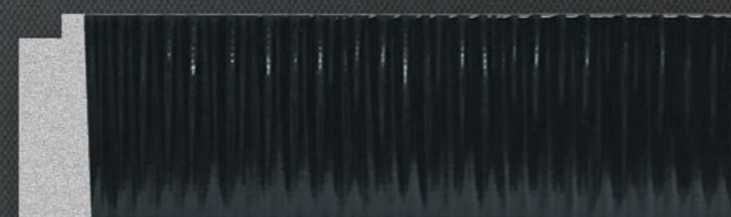
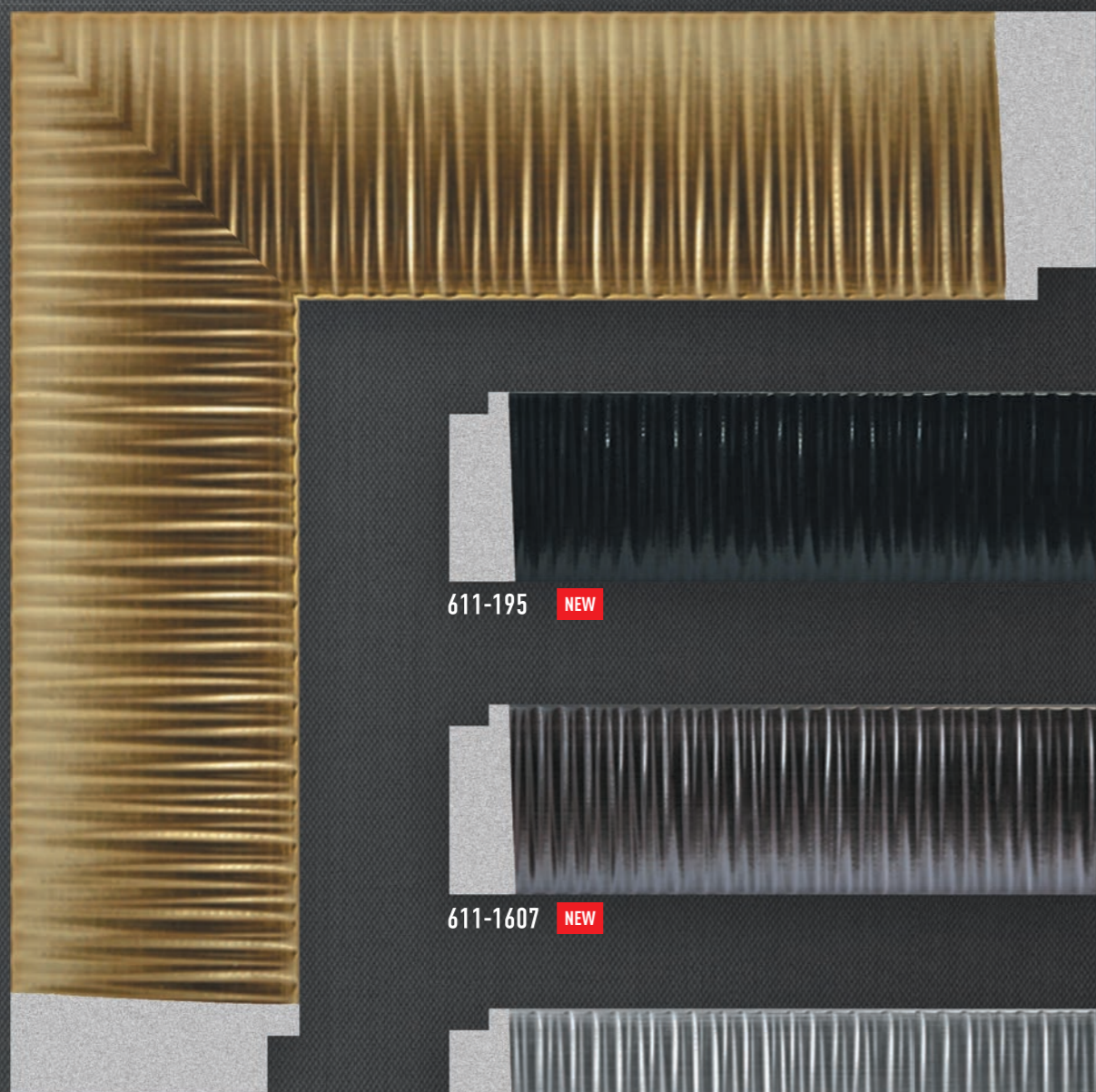

611-195 **NEW**



611-1607 **NEW**



611-1610 **NEW**

611-1608 **NEW**

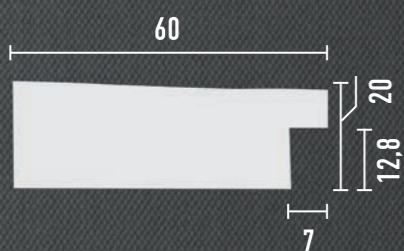

175-1



175-2



175-4



175-5



175-6

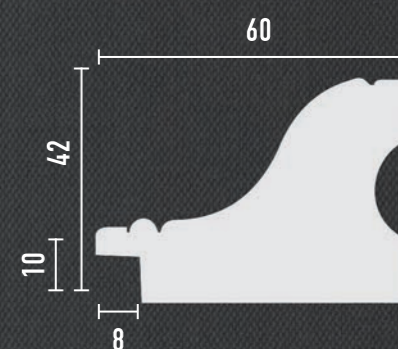

175-3



548M-440

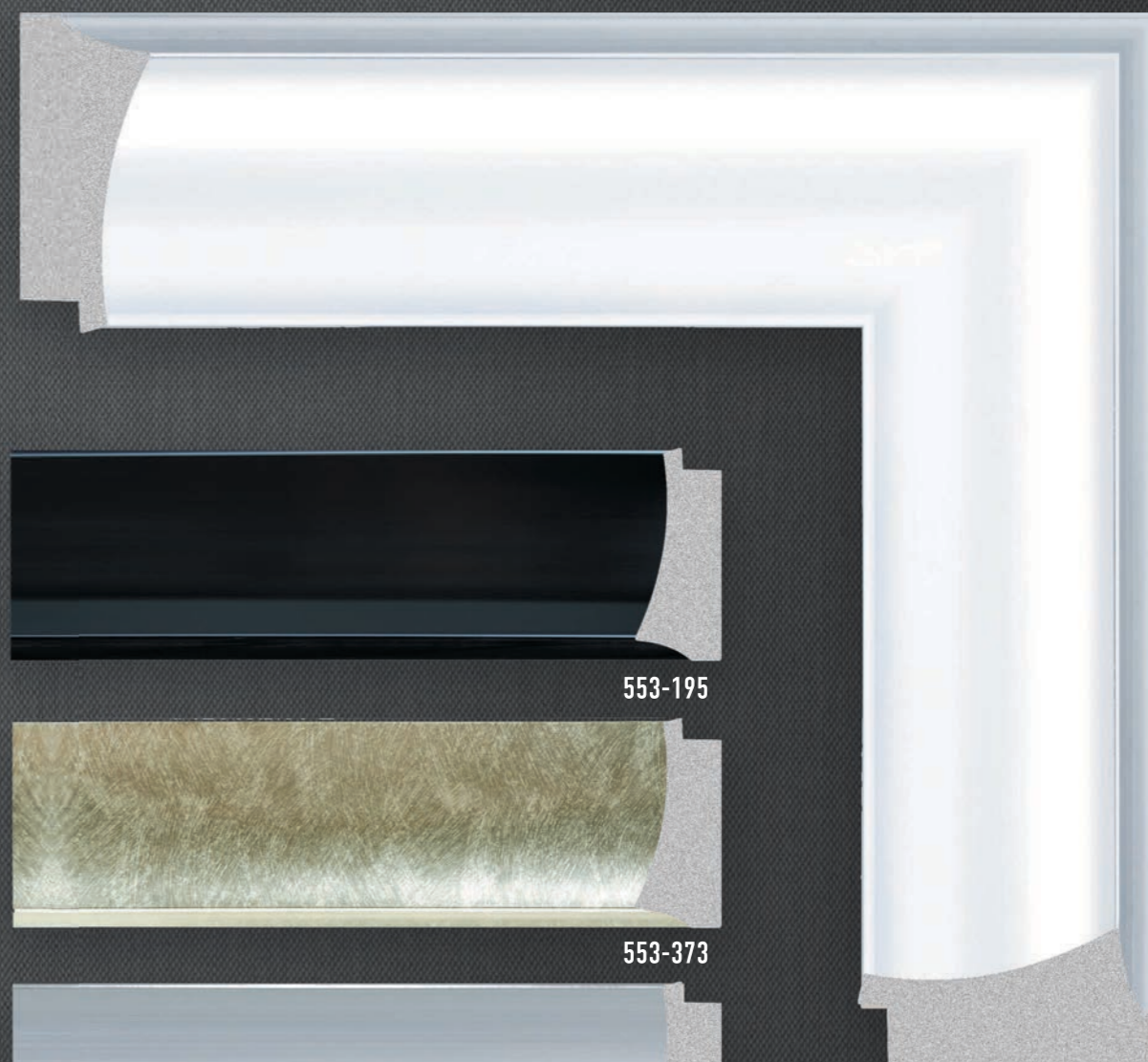
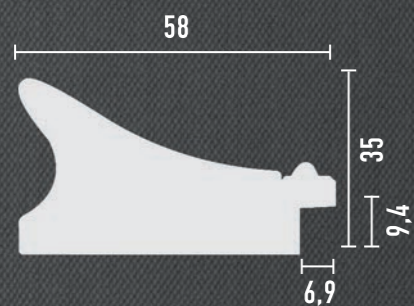

553-195

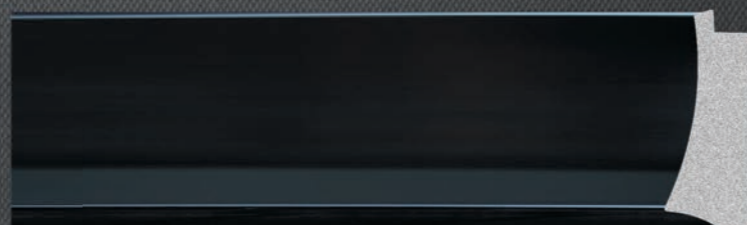

553-373



553-1153

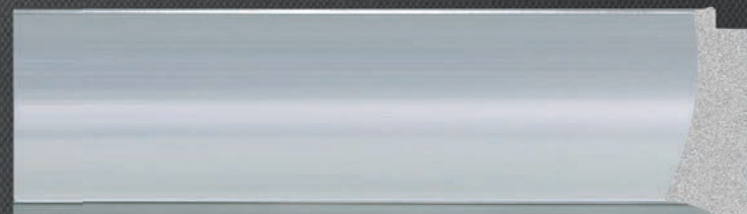

553-114

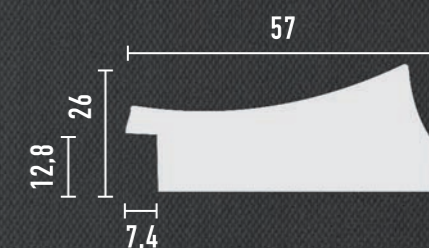



556-6



556-2



556-4



J11-966



J11-1223



J11-115



J11-1224

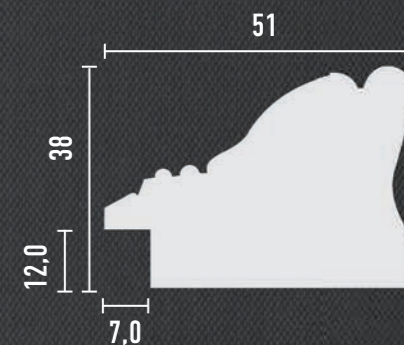



686M-565

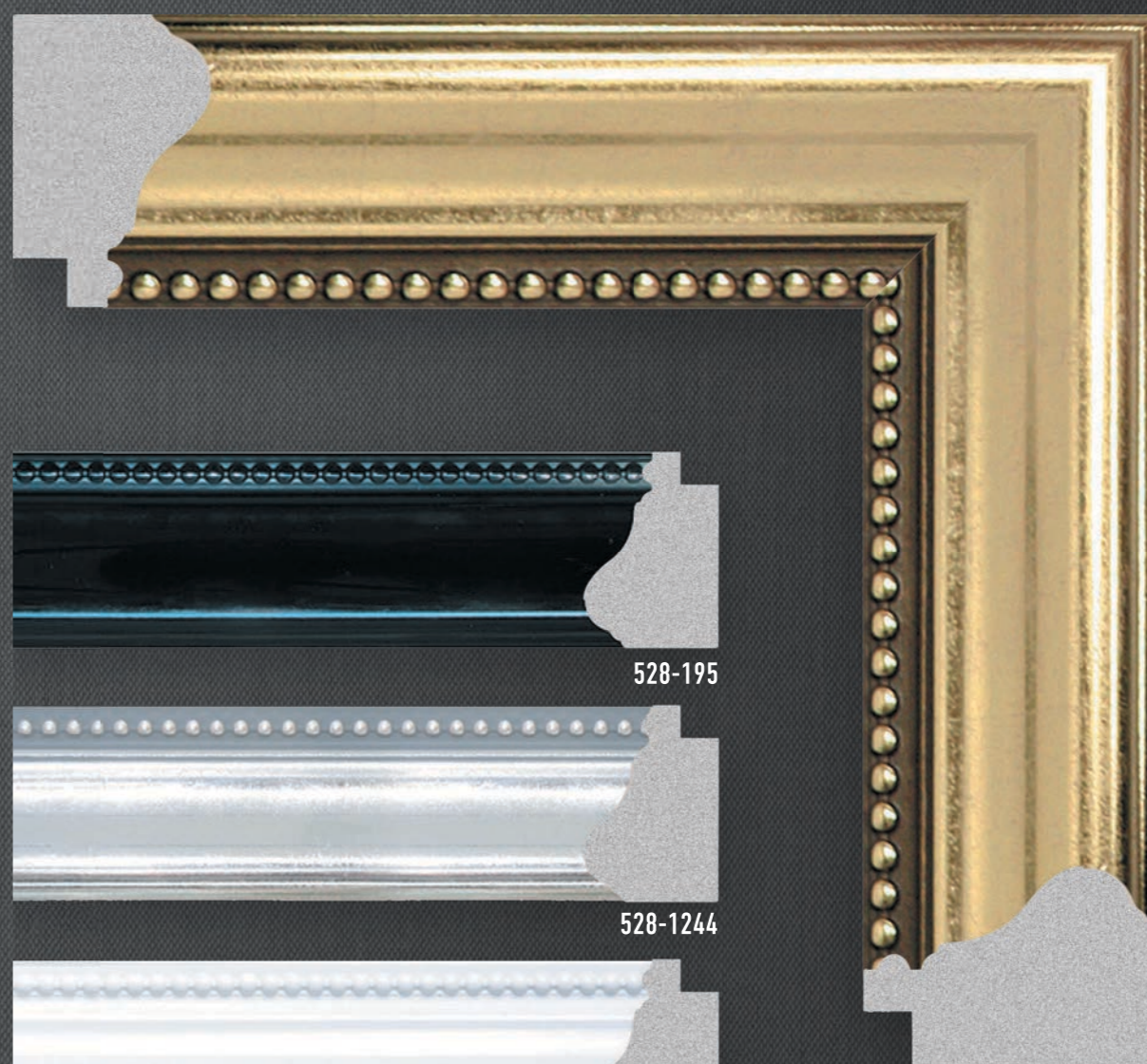
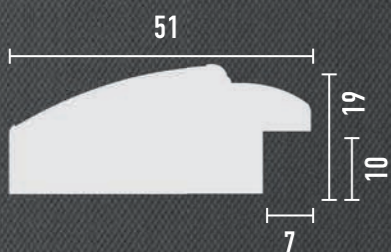

528-195

528-1244

528-114

528-1243

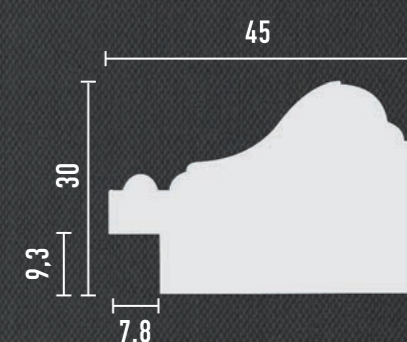



J13-966



J13-1223



J13-1224

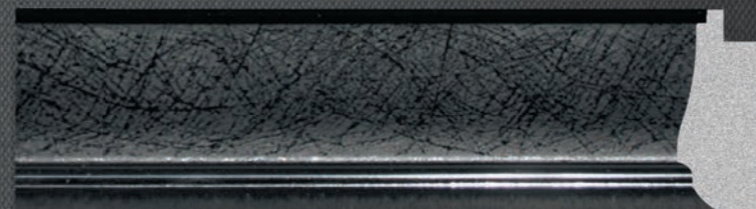
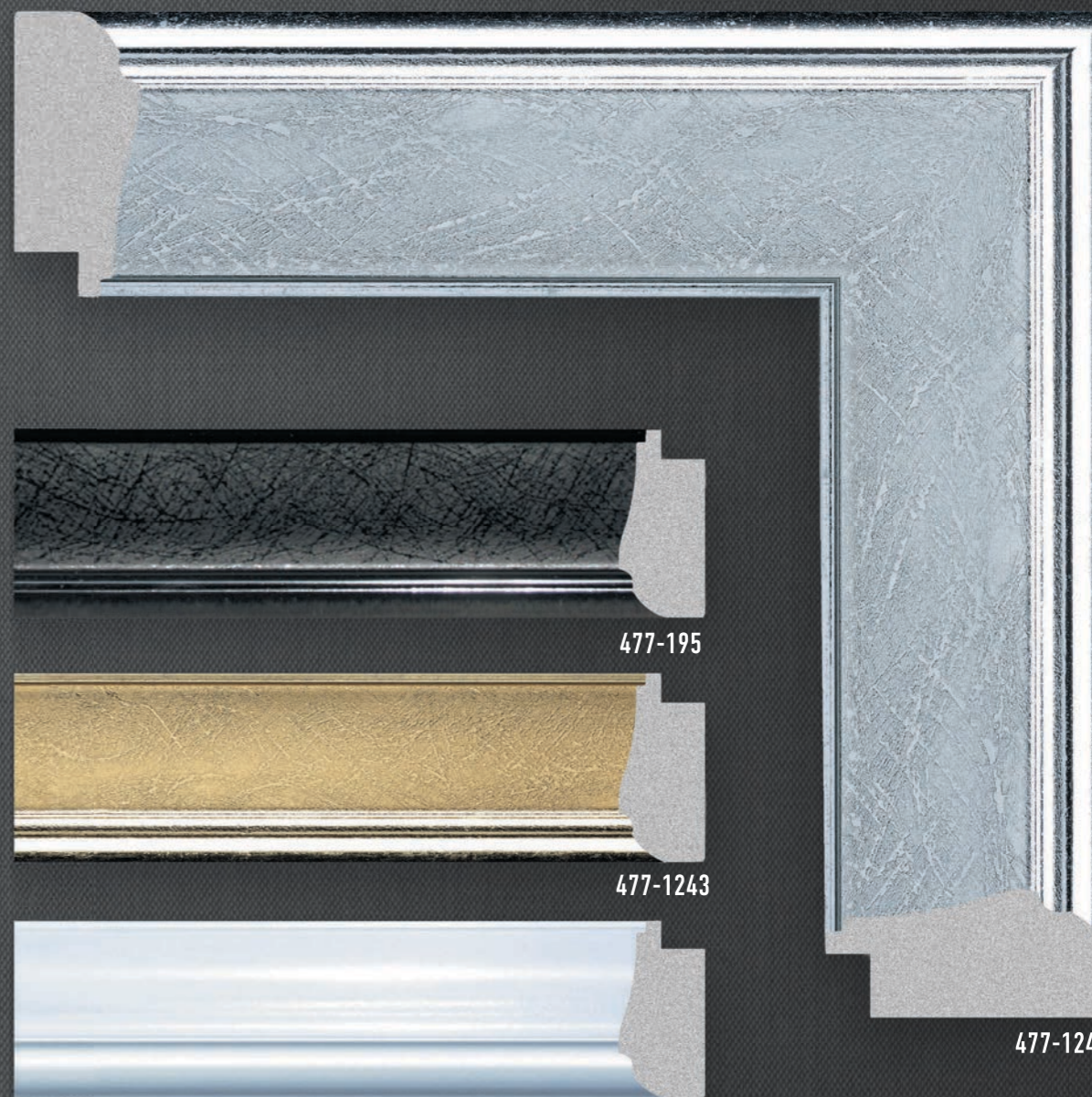
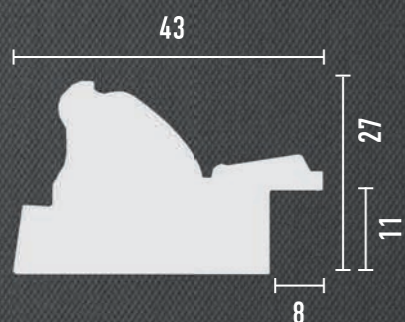

477-195



477-1243



477-114

477-1244

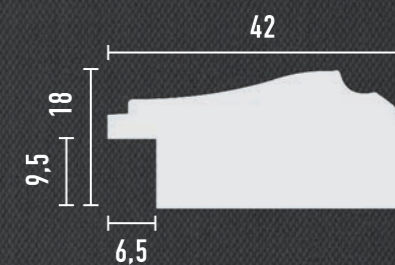



807-2



807-1



807-3



807-4



807-5



807-6



807-7D

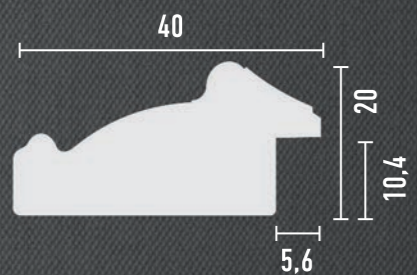

807-966



807-57



807-1223



807-58

807-56

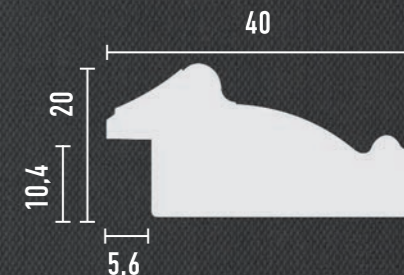



807-552



807-553



807-43



807-44



807-41



807-40



807-42

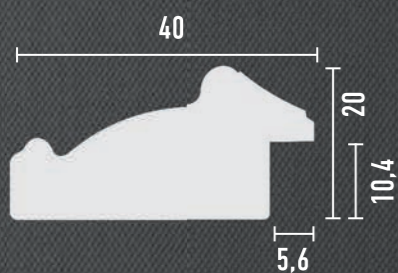

807-180



807-190



807-60



NEW 807-63

807-59

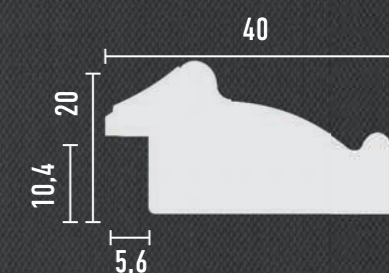



109-11

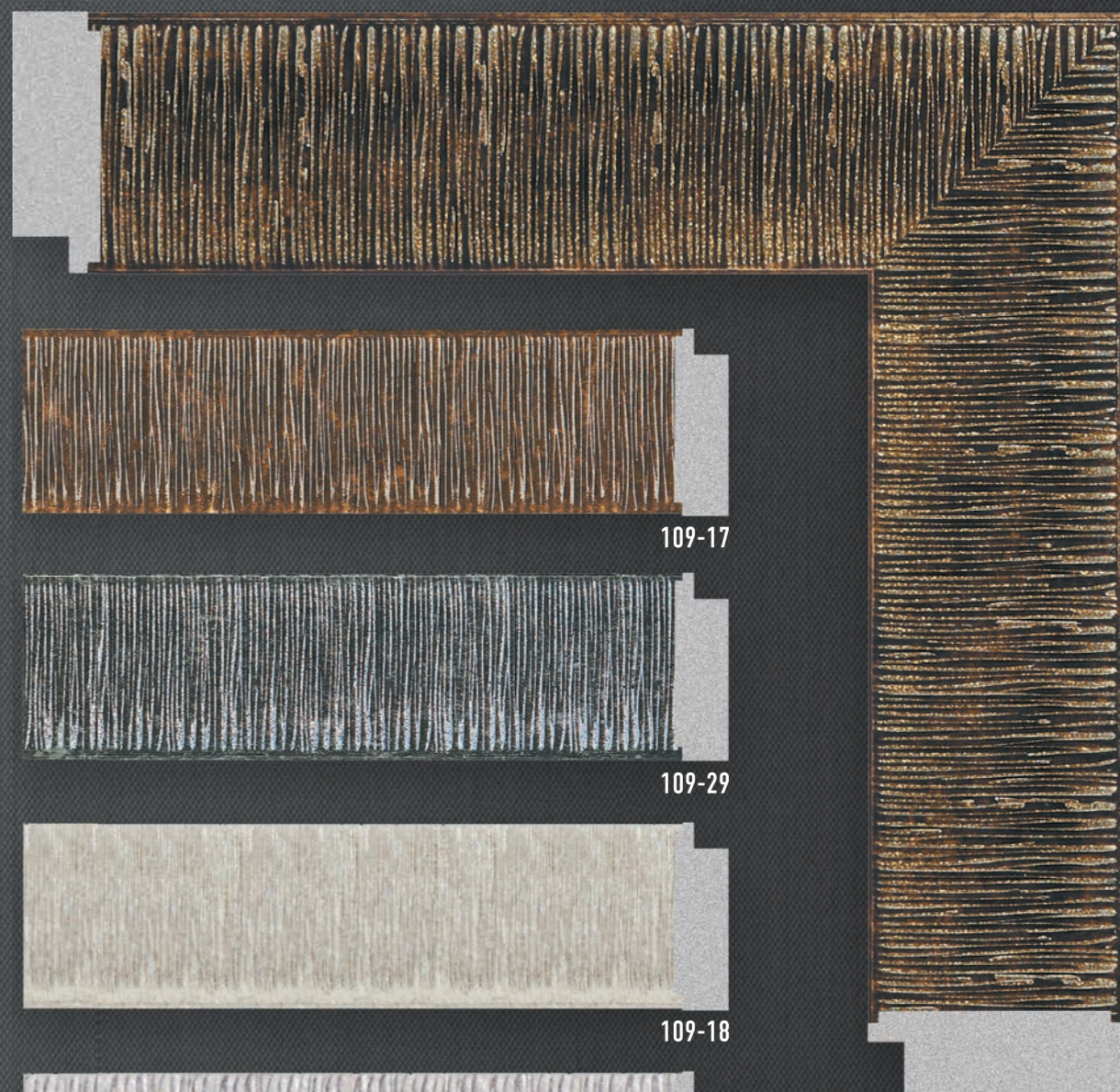
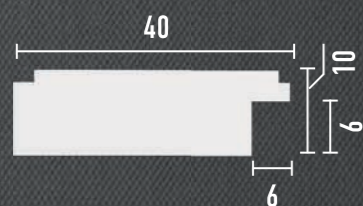

109-17

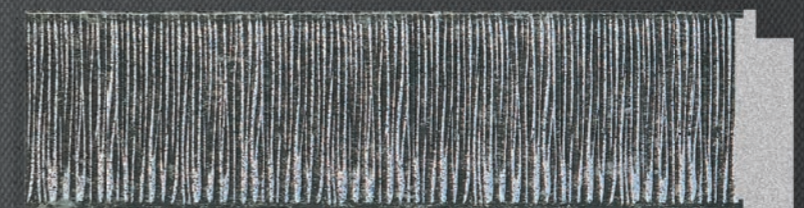

109-29



109-18



109-19



109-20

109-28

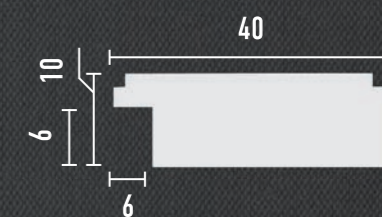

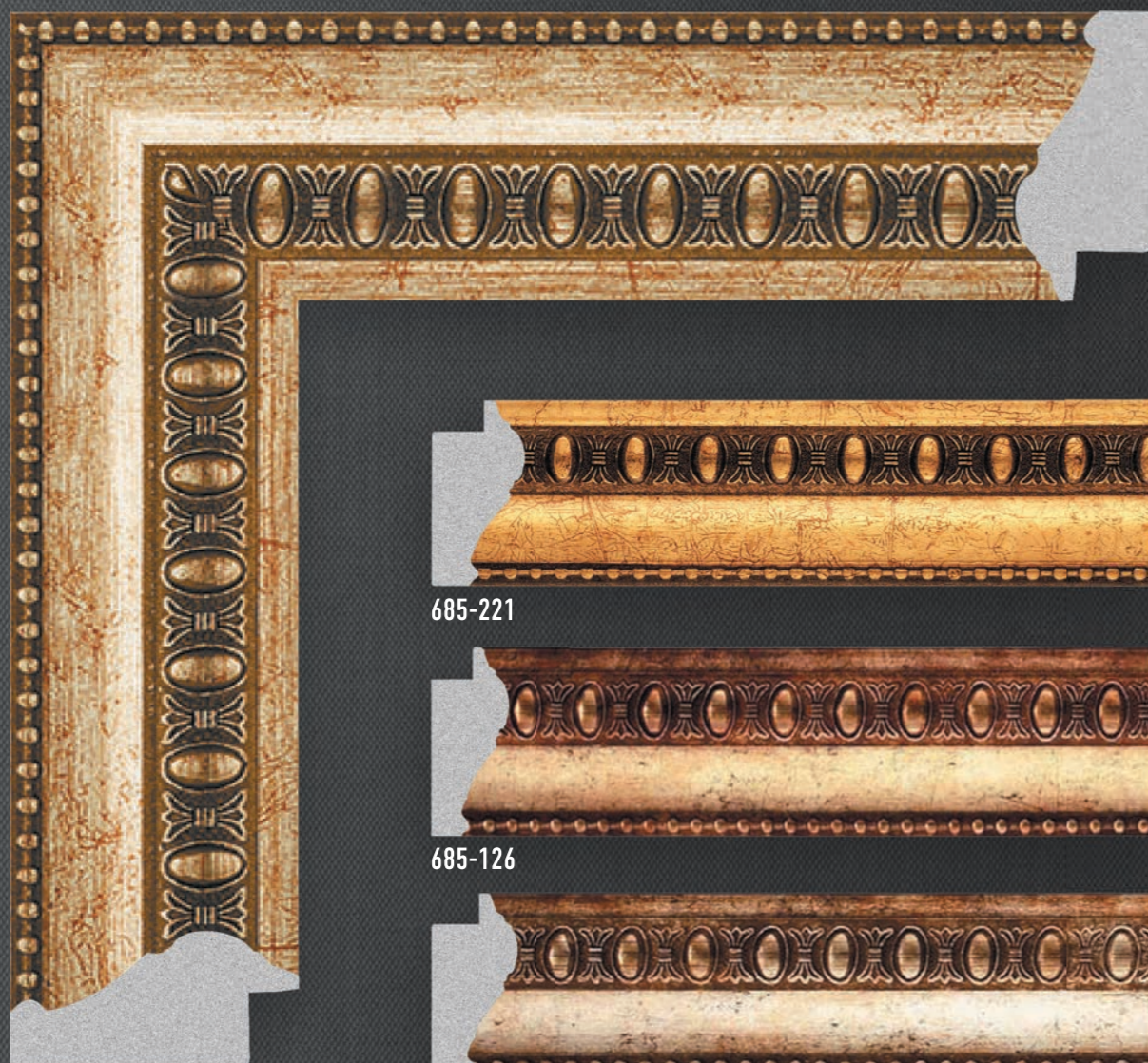

685-221



685-126



685-127



685-182

685-217

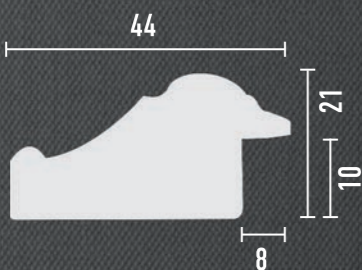

J12-1223



J12-1224

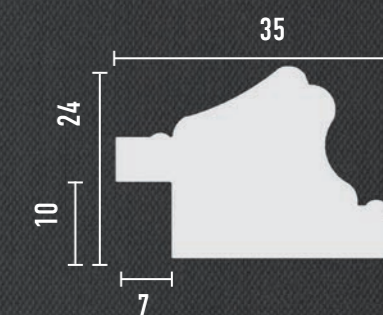

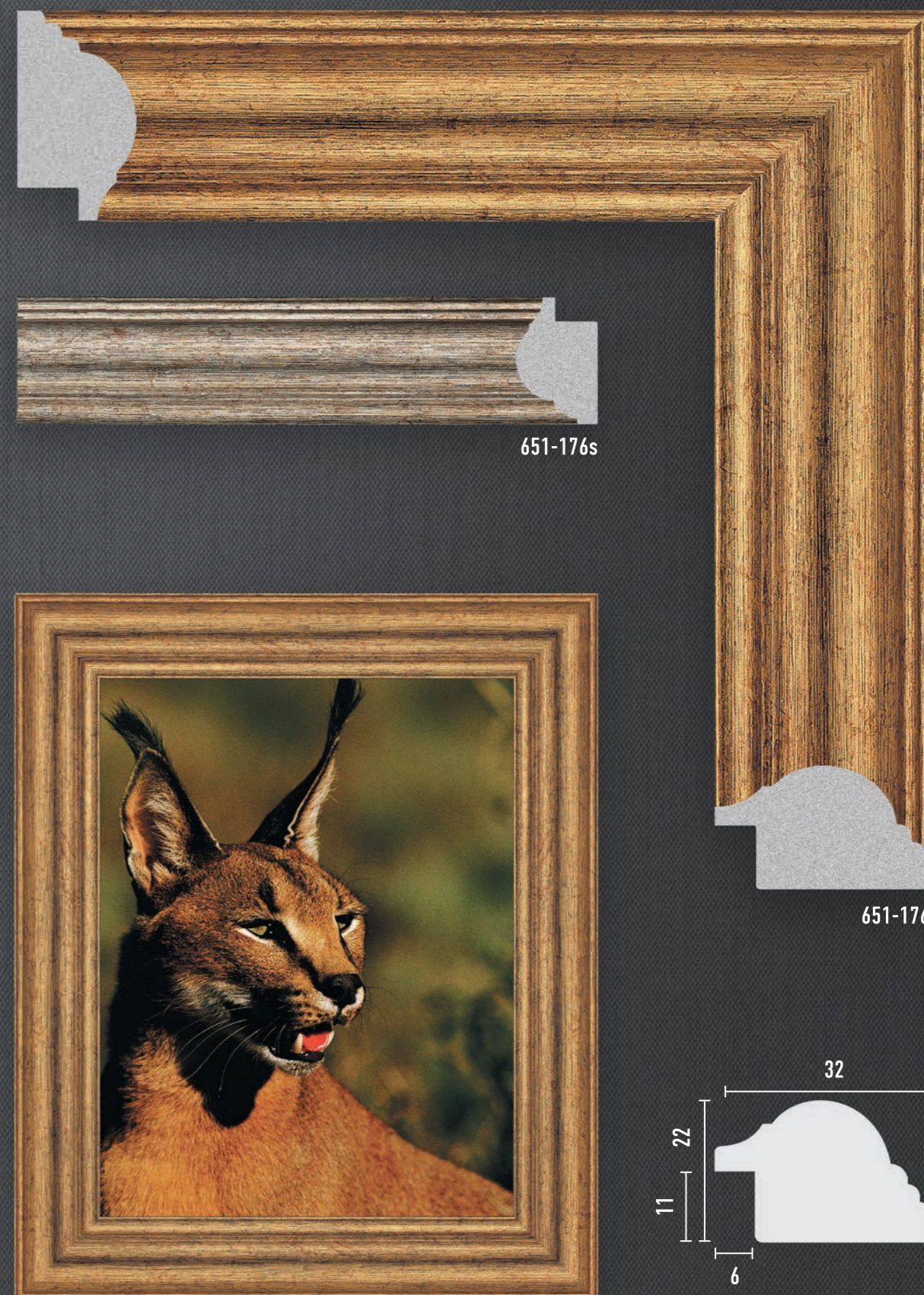



564-277

564-280

564-278

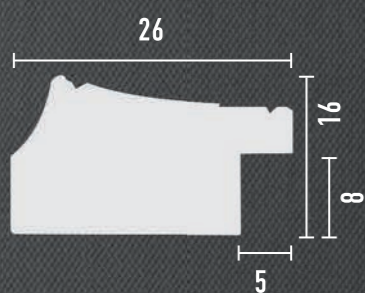

584-1070

584-1333

584-1069

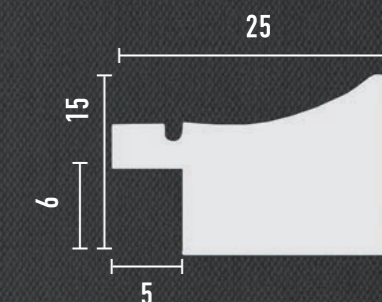

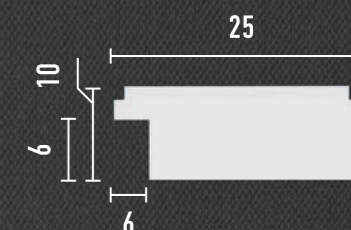
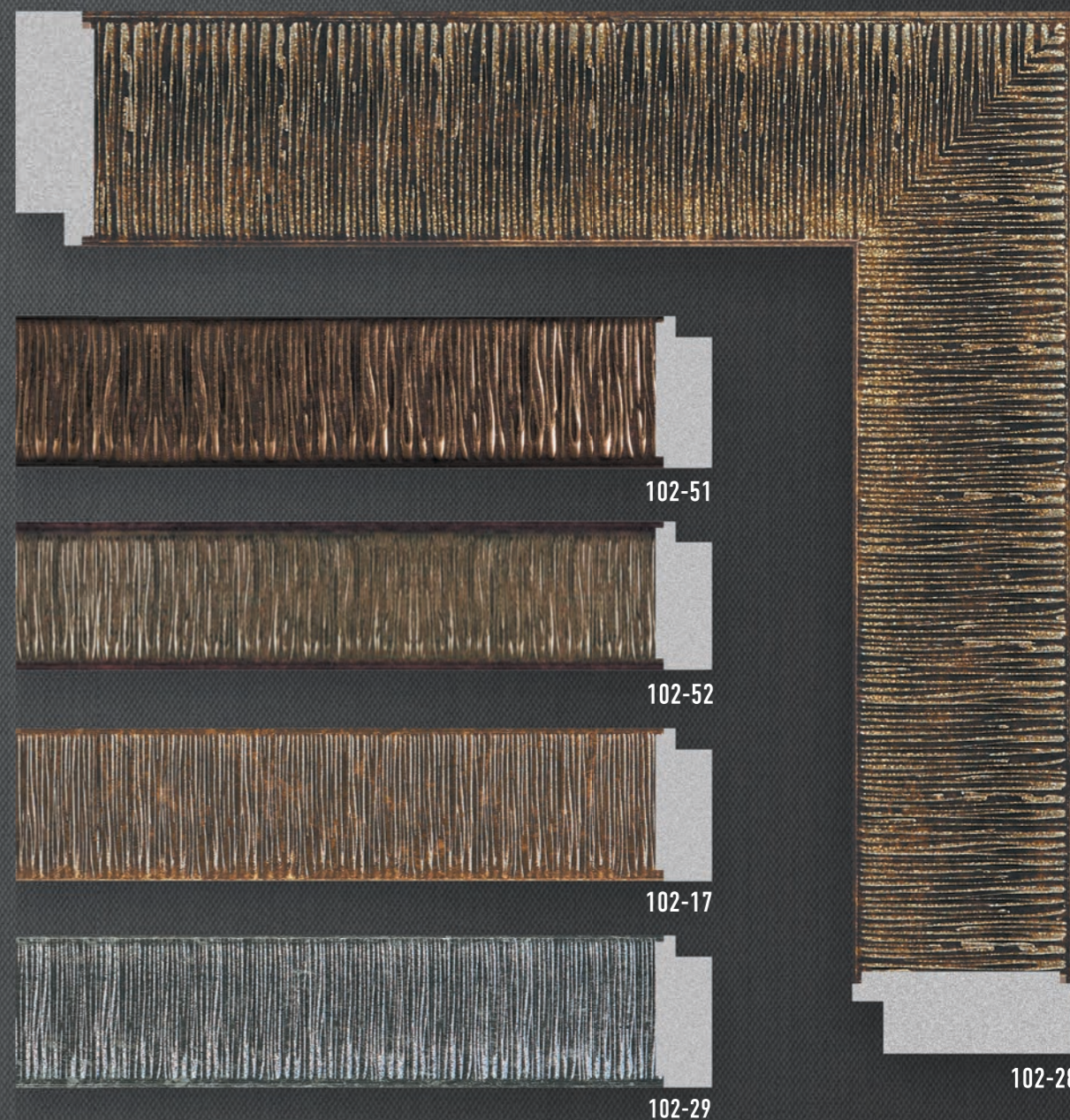

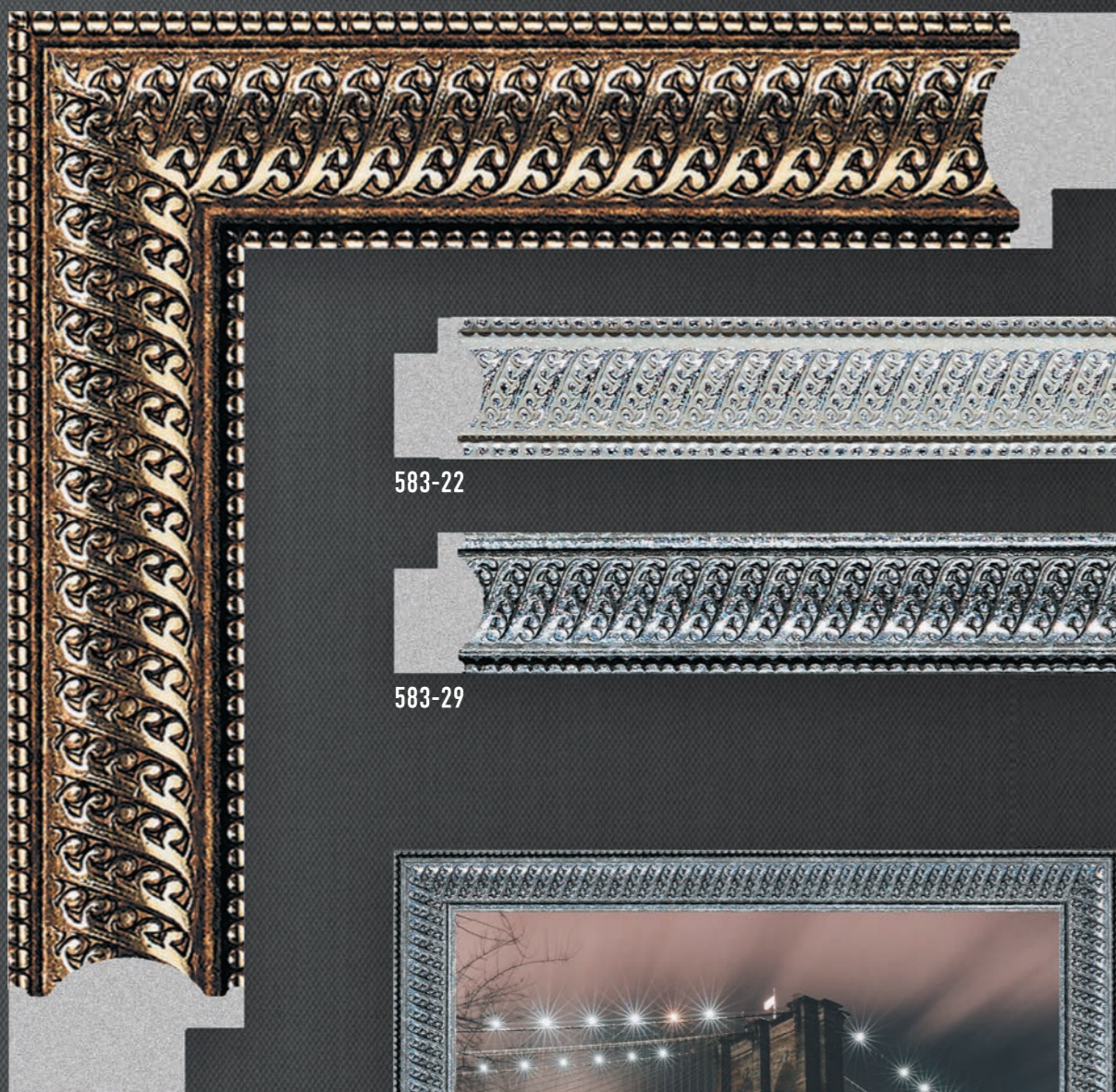

583-28



583-22



583-29

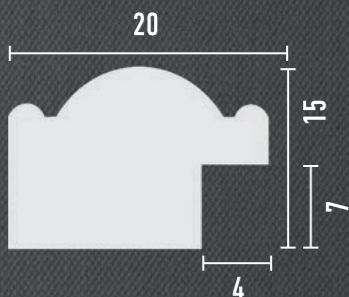

158-1



158-3



158-4



158-5



158-6



158-70



158-937



158-933



158-55

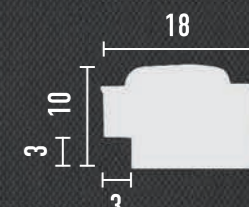



158-552



158-767



158-1084



158-553



158-54



158-115

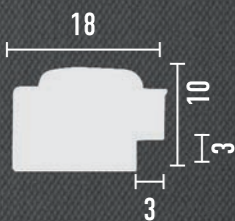

158-281



158-118



158-127



158-126



158-1028

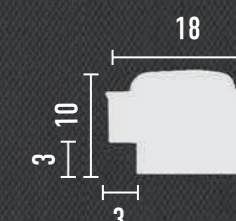

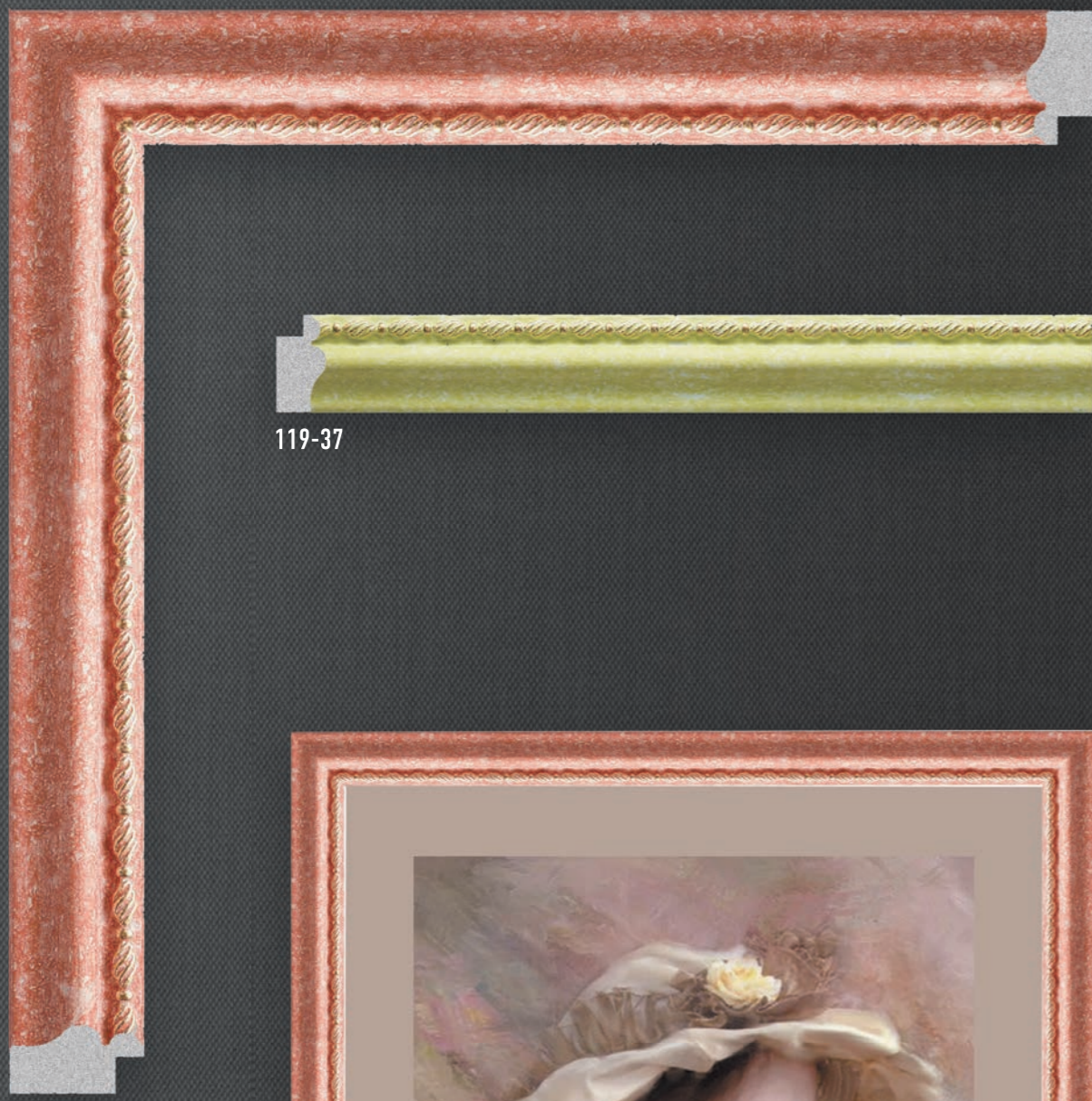

119-37

119-34

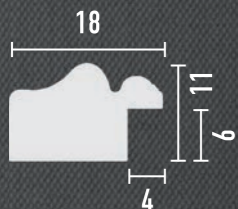

149-956

149-954

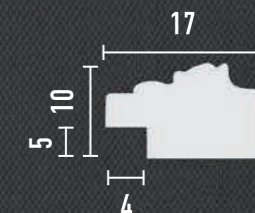



117-438



117-553



117-552

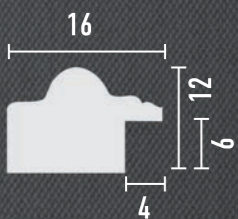

159B-565



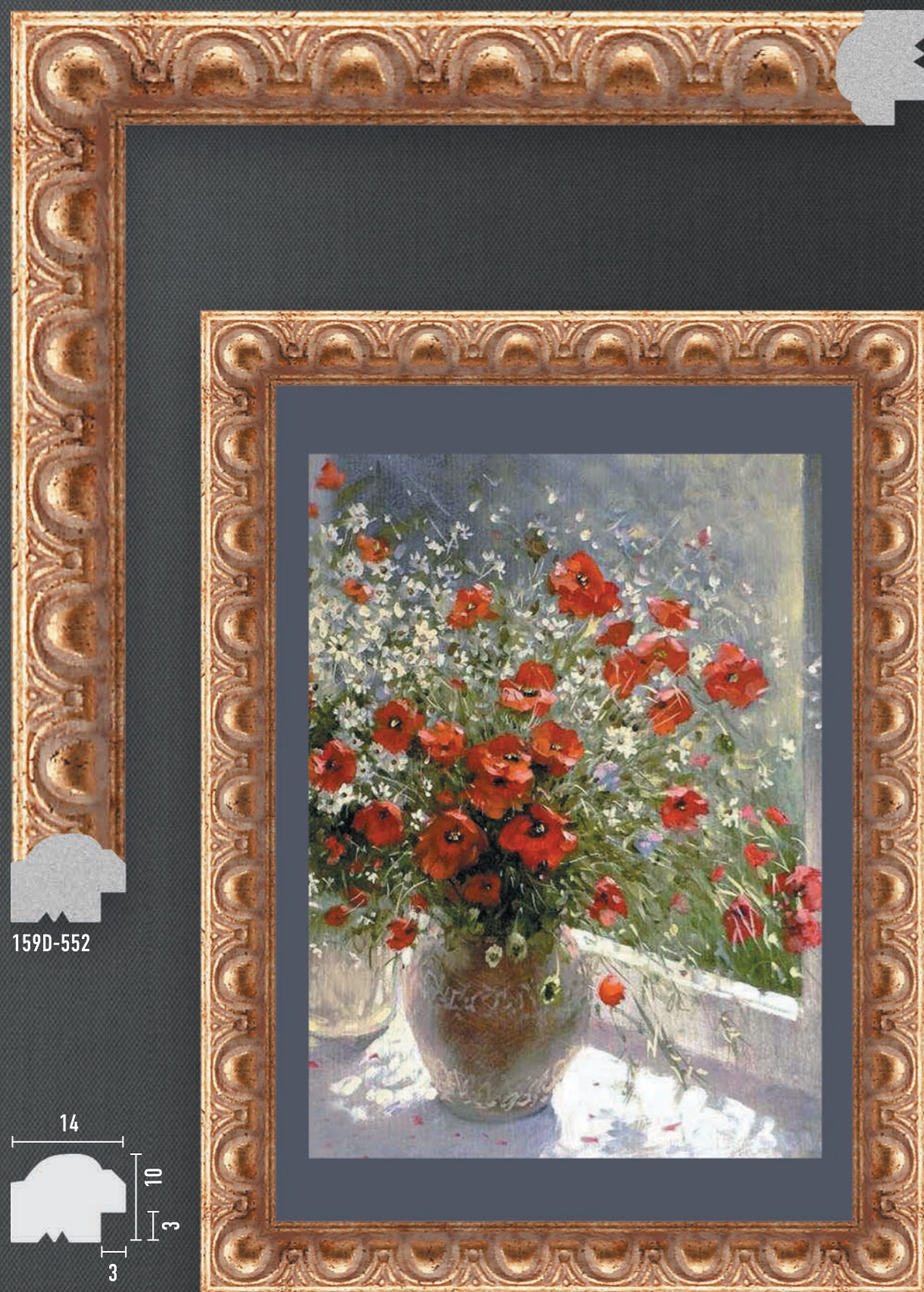

159D-552

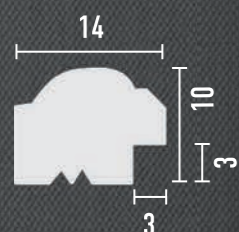

118-29

118-17

118-19

118-20

118-18





FM22-1



FM22-3



FM22-4

FM22-2

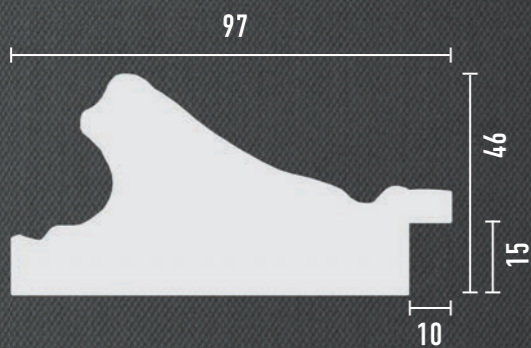

FM9-1



FM9-3



FM9-4



FM9-5

FM9-2

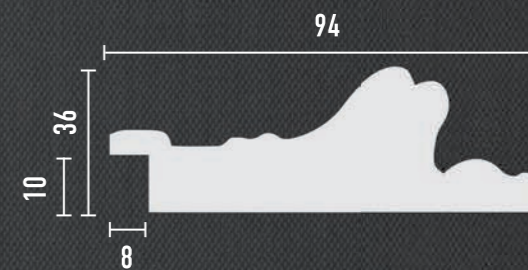



FM28-2



FM28-1

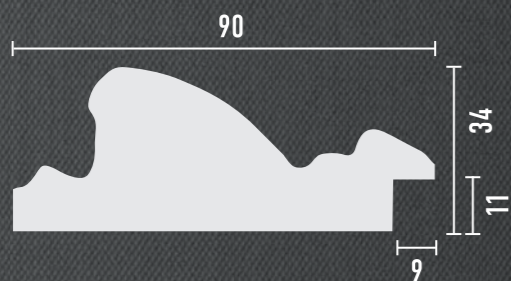

FM26-1



FM26-2

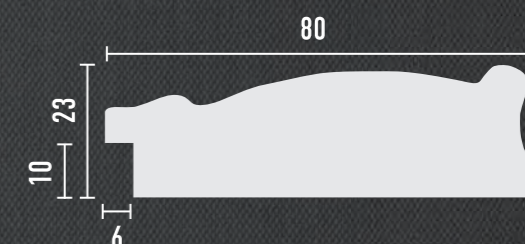



FM8-1

FM8-2

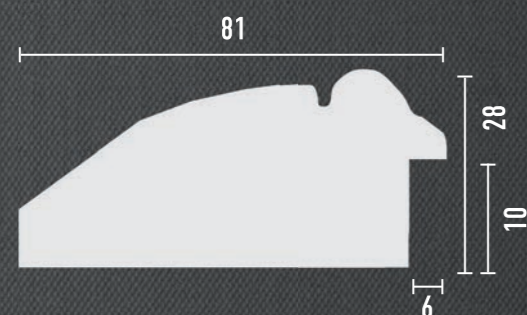

FM4-3

FM4-1

FM4-4

FM4-2

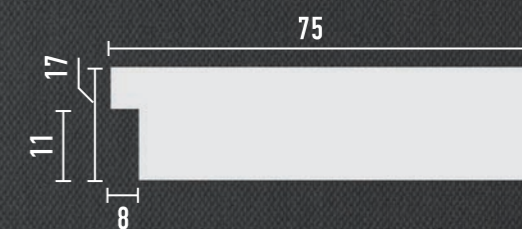



FM29-2

FM29-1

FM29-3

FM29-4

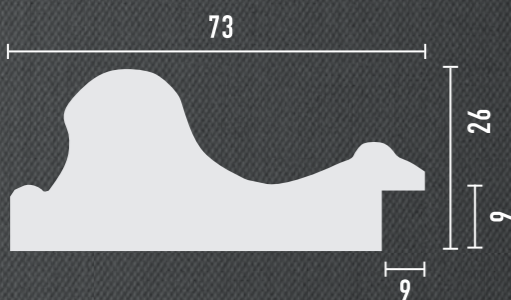

FM25-1

FM25-2

FM25-3

FM25-4

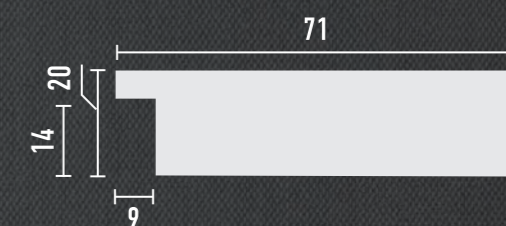



FM24-1 **NEW**

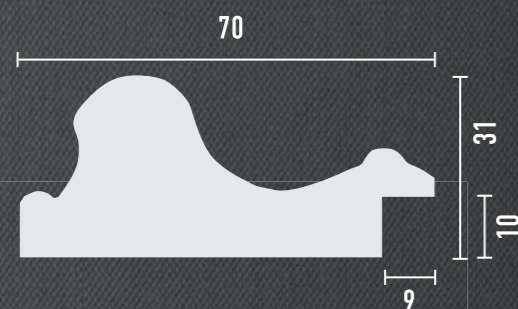

FM11-2

FM11-1

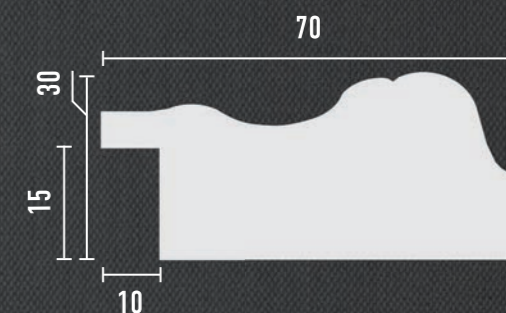



FM14-1

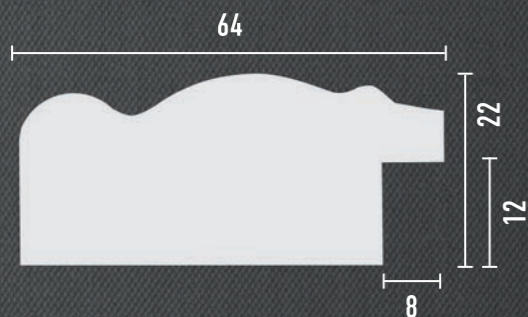

FM21-1

FM21-2

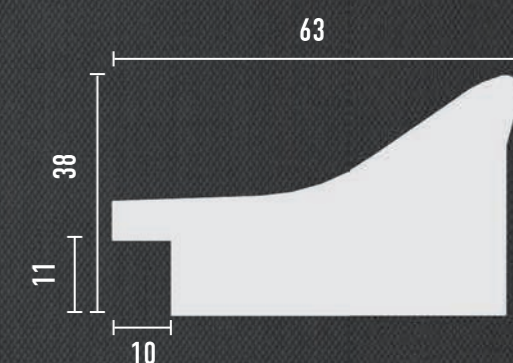



FM10-3



FM10-2



FM10-1



FM10-4



FM10-5



FM31-1

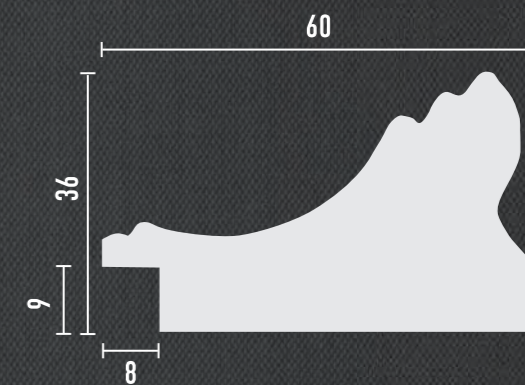



FM19-1

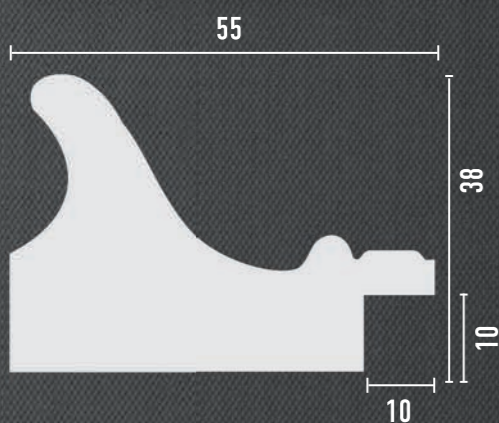

FM19-2



FM21-1





FM17-1

FM17-2

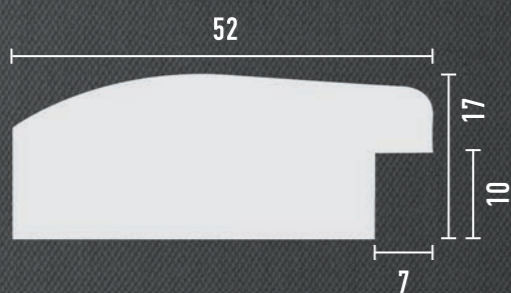
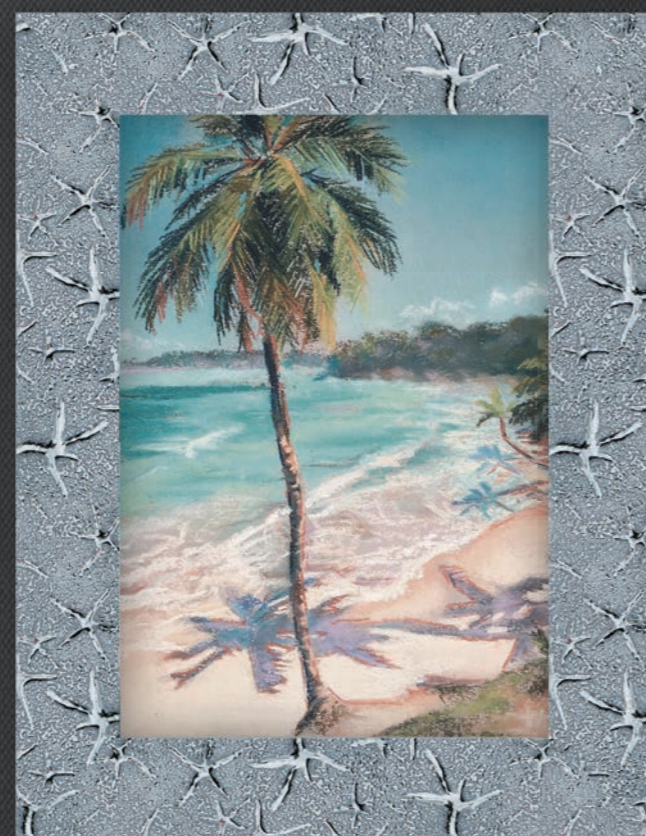

FM15-2



FM15-1

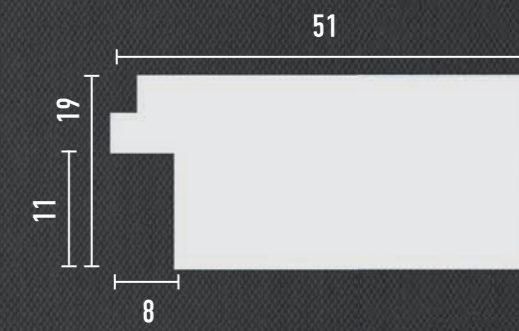



FM30-2

FM30-1

FM30-3

FM30-4

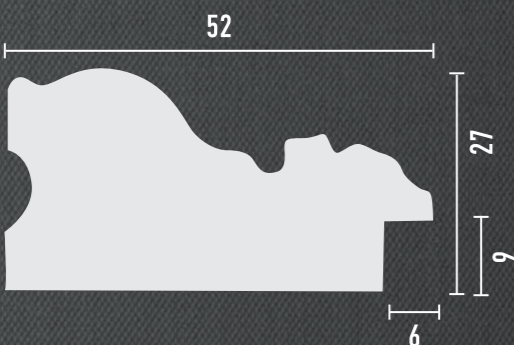

FM23-1

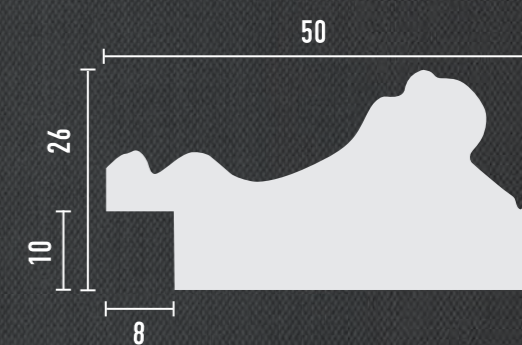



FM12-1



FM12-2

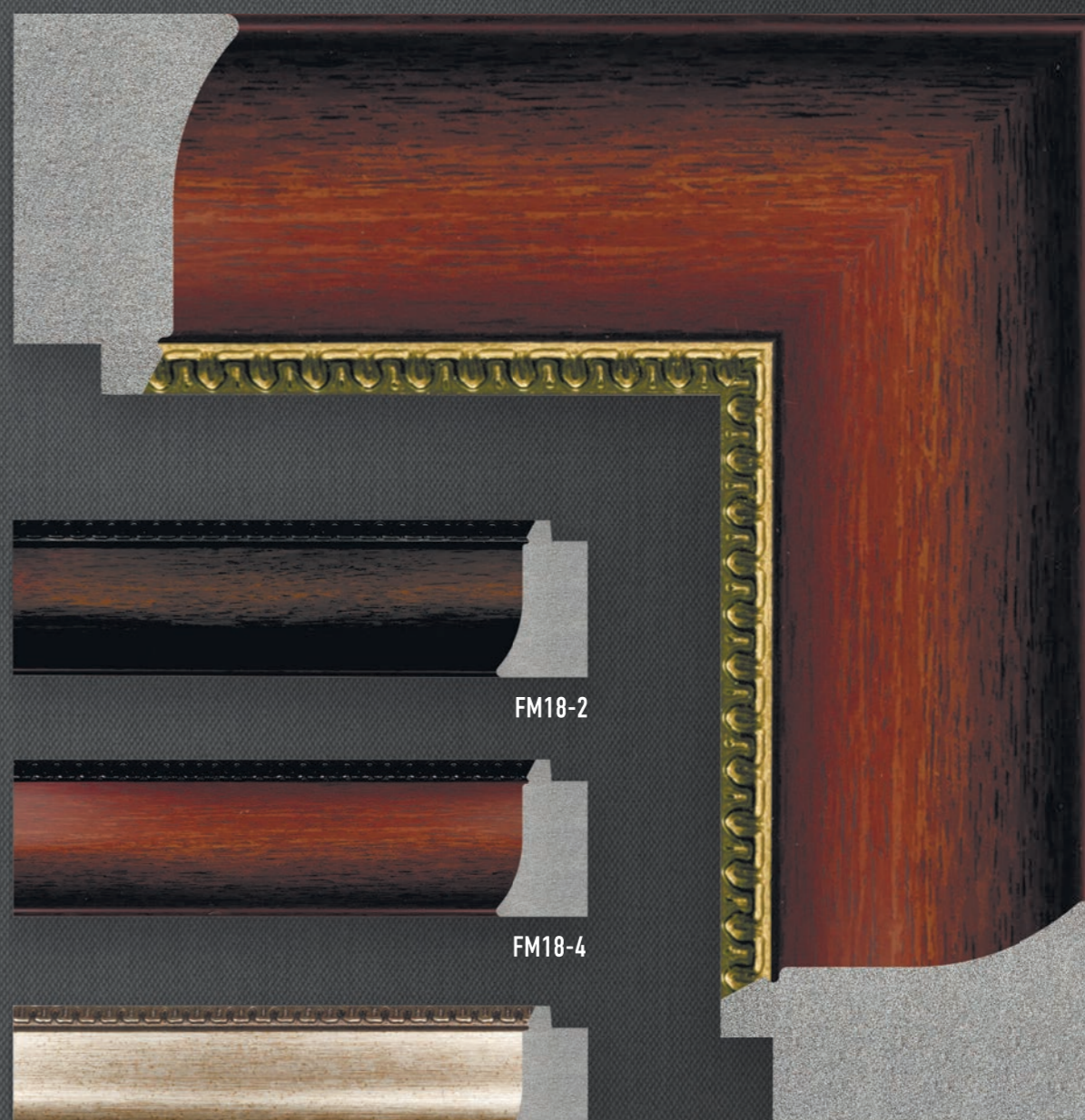
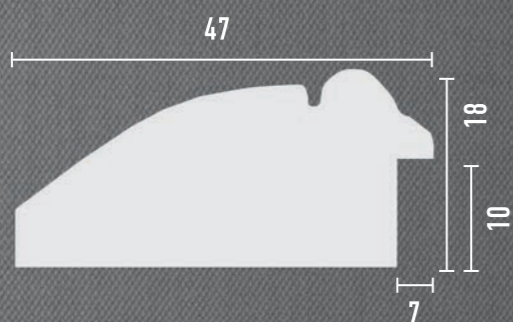

FM18-2



FM18-4



FM18-1



FM18-3

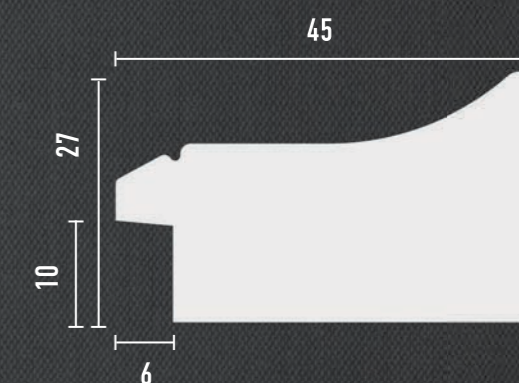

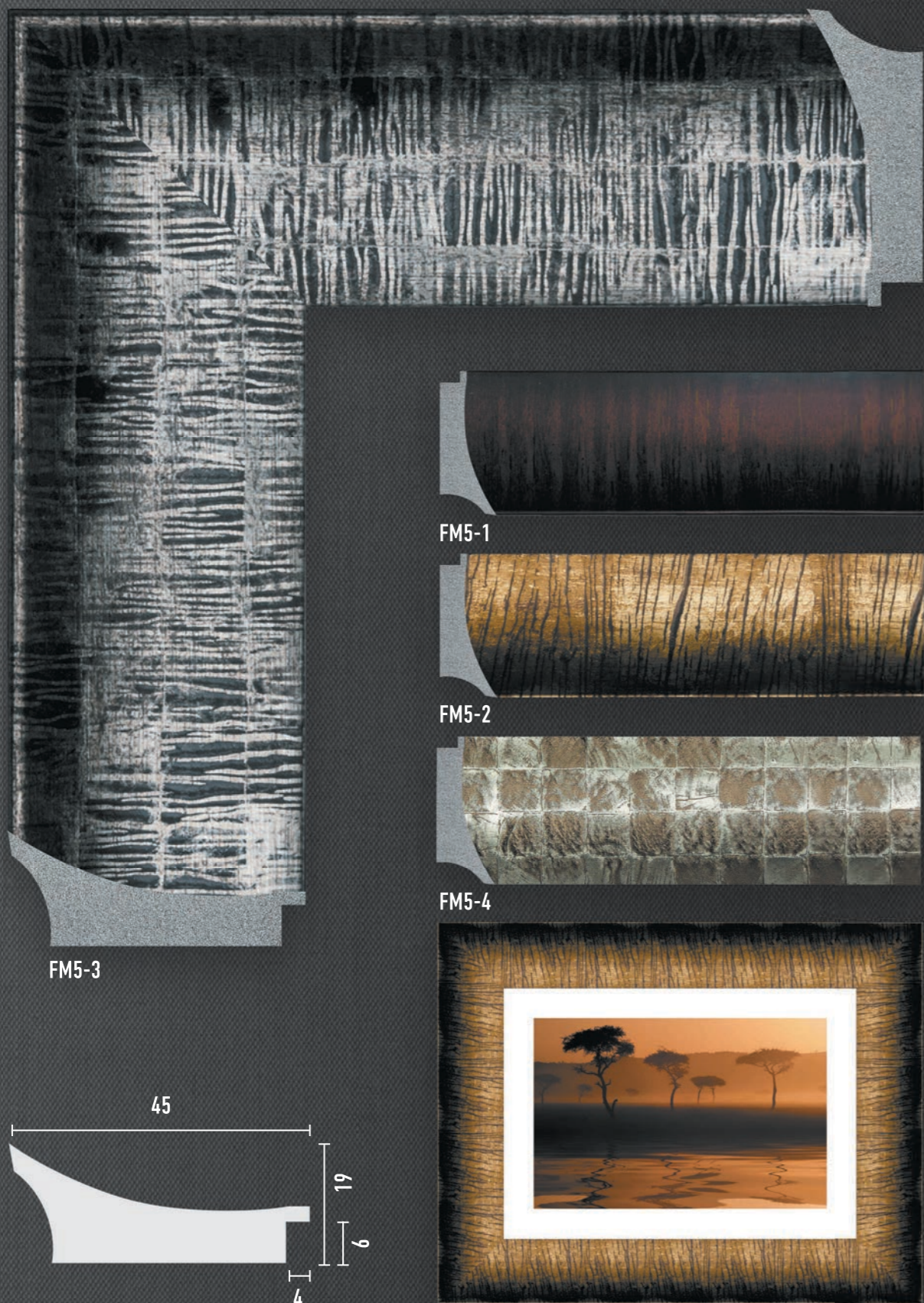



FM20-1

FM20-2

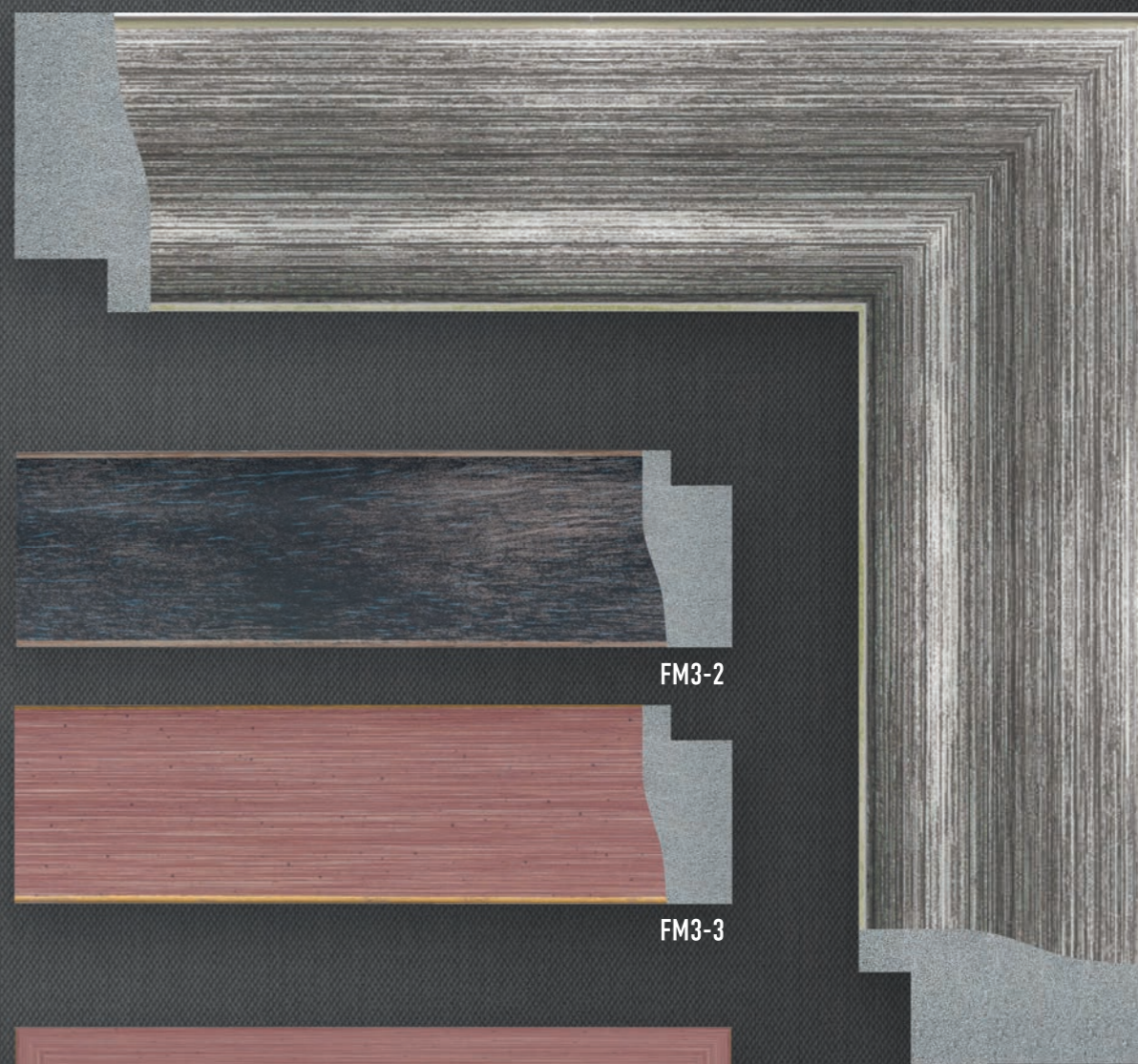
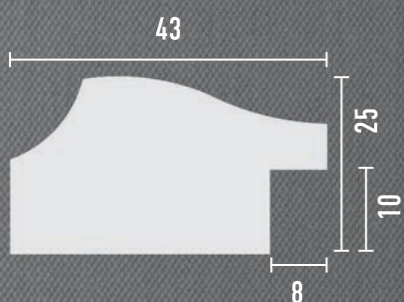

FM3-2

FM3-3

FM3-1

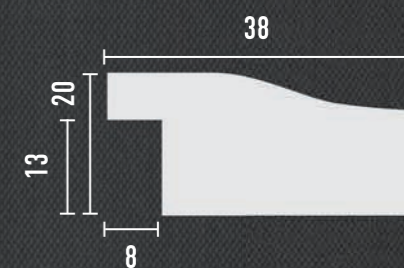



FM16-1

FM16-2

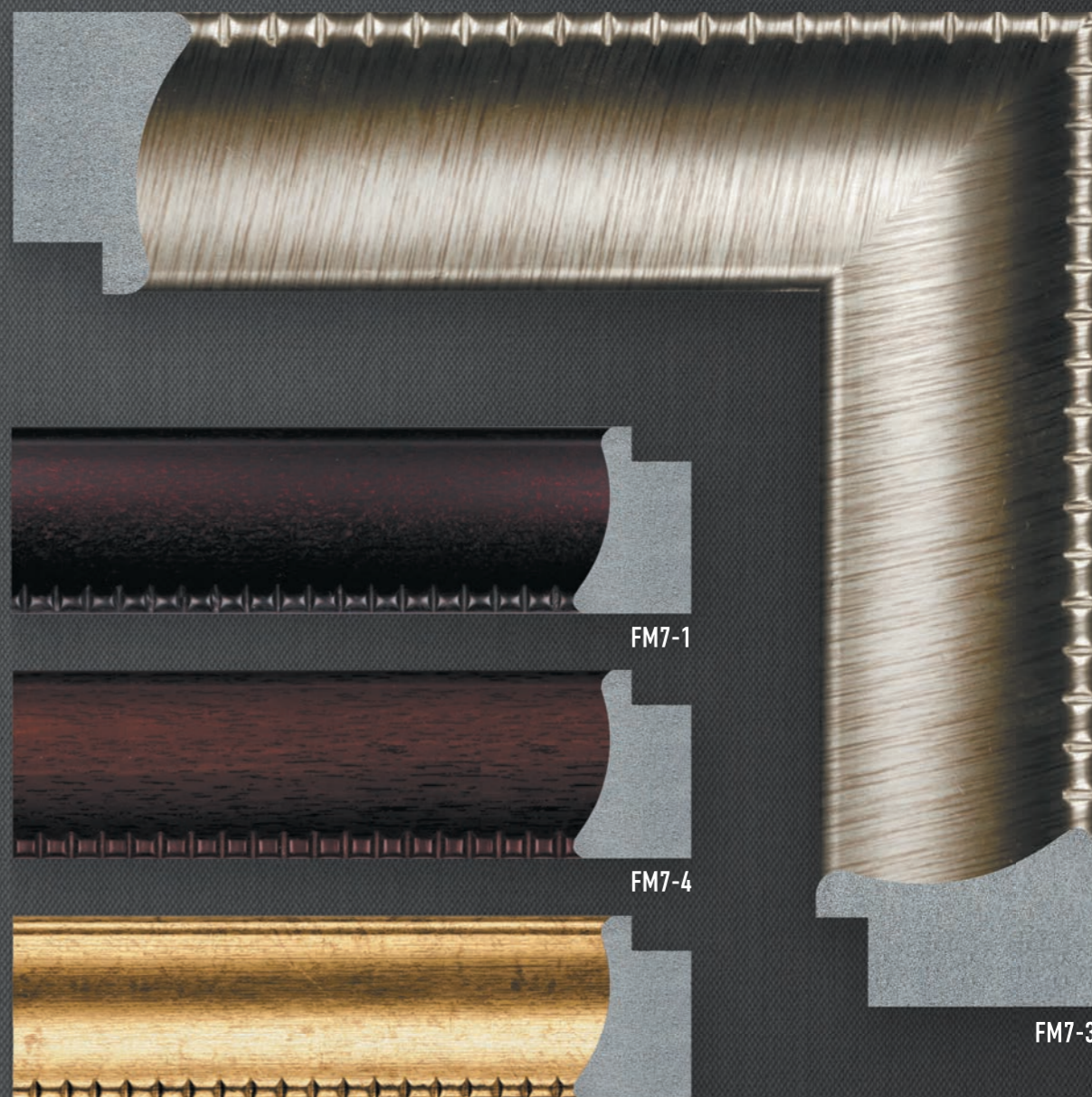
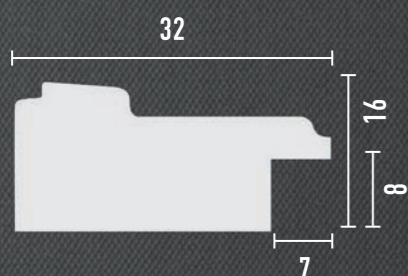

FM7-1

FM7-4

FM7-2

FM7-3

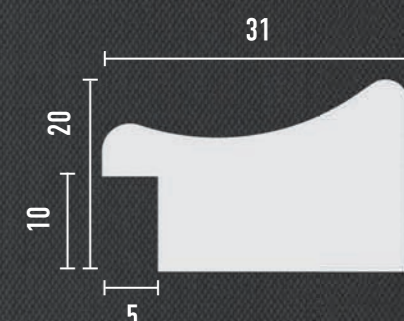



FM2-1

FM2-3

FM2-2

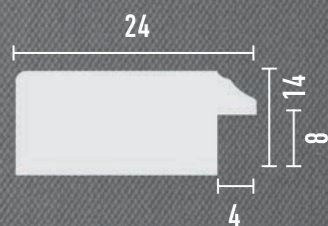

BFBA001/1SM

BFBA001/1NM

BFBA001/1BM

BFBA001/1WG

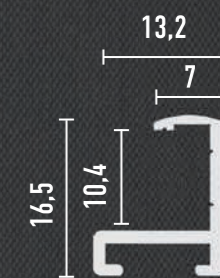

СОДЕРЖАНИЕ

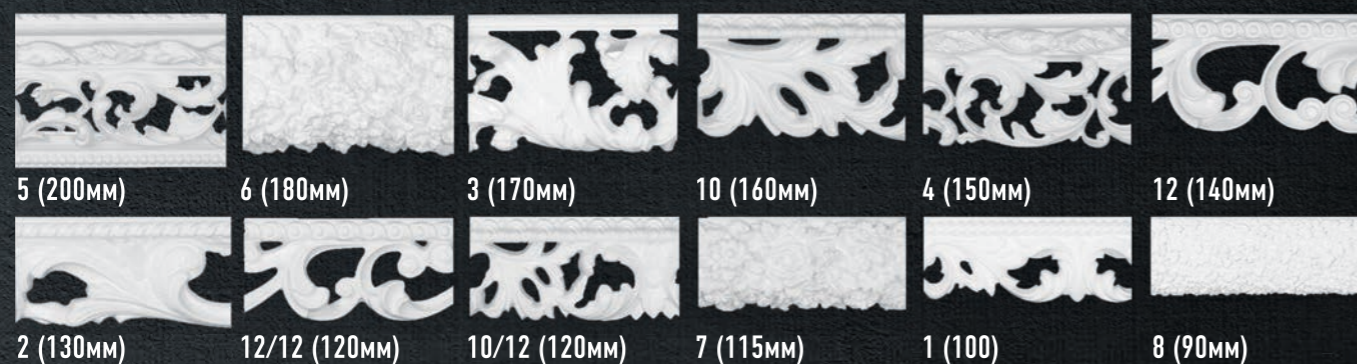

Артикул	Стр.	Артикул	Стр.	Артикул	Стр.	Артикул	Стр.	Артикул	Стр.	Артикул	Стр.	Артикул	Стр.
102-15	68	158-552	72	413-1607	16	556-4	50	807-3	56	BFBA001/1WG	109	FM18-4	101
102-17	69	158-553	72	413-1608	16	556-6	50	807-4	56	BFBA001/1BM	109	FM19-1	94
102-18	68	158-6	71	413-1609	16	564-277	66	807-40	58	BFBA001/1SM	109	FM19-2	94
102-19	68	158-7D	71	477-114	55	564-278	66	807-41	58	BFBA001/1NM	109	FM20-1	104
102-20	68	158-767	72	477-1243	55	564-280	66	807-42	58	FM2-1	108	FM20-2	104
102-28	69	158-933	71	477-1244	55	566-1606	38	807-43	58	FM2-2	108	FM21-1	91
102-29	69	158-937	71	477-195	55	566-1607	38	807-44	58	FM2-3	108	FM21-2	91
102-51	69	159B-565	77	516-126	23	566-1608	38	807-5	56	FM3-1	105	FM22-1	80
102-52	69	159D-552	78	516-127	23	566-1609	38	807-56	57	FM3-2	105	FM22-2	80
108-7	35	175-1	47	516-1069	22	566-1223	38	807-57	57	FM3-3	105	FM22-3	80
108-1333	35	175-2	47	516-1070	23	566-1224	38	807-58	57	FM4-1	85	FM22-4	80
108-1069	35	175-3	47	516-1333	22	577-1223	37	807-59	59	FM4-2	85	FM23-1	99
108-17	36	175-4	47	516-767	23	577-966	37	807-552	58	FM4-3	85	FM24-1	88
108-18	36	175-5	47	524-1069	40	582-26	33	807-553	58	FM4-4	85	FM25-1	87
108-19	36	175-6	47	524-1070	40	582-27	33	807-6	56	FM5-1	102	FM25-2	87
108-20	36	176-1	41	524-1333	40	582-440	33	807-60	59	FM5-2	102	FM25-3	87
108-28	36	176-2	41	527-114	30	582-433	33	807-63	59	FM5-3	102	FM25-4	87
108-29	36	176-3	41	527-1243	30	582-438	33	807-966	57	FM5-4	102	FM26-1	83
109-11	60	176-4	41	527-1244	30	583-22	70	807-70	56	FM6-1	103	FM26-2	83
109-17	61	176-5	41	527-195	30	583-28	70	808-176S	44	FM6-2	103	FM27-1	95
109-18	61	176-6	41	527-725	30	583-29	70	808-552	44	FM7-1	107	FM28-1	82
109-19	61	214-3	12	528-114	53	584-1333	67	808-553	44	FM7-2	107	FM28-2	82
109-20	61	214-373	12	528-1243	53	584-1069	67	811M-905	34	FM7-3	107	FM29-1	86
109-28	61	214-6	12	528-1244	53	584-1070	67	811M-906	34	FM7-4	107	FM29-2	86
109-29	61	229-182	9	528-195	53	587-70	45	829-294	42	FM8-1	84	FM29-3	86
117-438	76	229-1068	9	534-11	64	587-1604	45	829-934	42	FM8-2	84	FM29-4	86
117-552	76	229-1223	8	534-13	64	587-1604B	45	829-935	42	FM9-1	81	FM30-1	98
117-553	76	229-645	8	534-14	64	587-1605	45	849-373	20	FM9-2	81	FM30-2	98
118-17	79	229-955	8	534-15	64	587-1605B	45	849-565	20	FM9-3	81	FM30-3	98
118-18	79	229-966	8	534-51	64	611-195	46	849-566	20	FM9-4	81	FM30-4	98
118-19	79	230-70	6	534-52	64	611-1607	46	849-919	19	FM9-5	81	FM31-1	93
118-20	79	230-1223	6	534-53	64	611-1608	46	868-645	21	FM10-1	92	J11-115	51
118-29	79	230-966	6	548M-440	48	611-1610	46	916-247	11	FM10-2	92	J11-966	51
119-34	74	230-1543	6	552-114	24	651-176	65	916-393	11	FM10-3	92	J11-1223	51
119-37	74	230-1604B	6	552-1153	24	651-176S	65	916-397	11	FM10-4	92	J11-1224	51
149-954	75	230-1605B	6	552-195	24	685-126	62	916-461	11	FM10-5	92	J12-1223	63
149-956	75	230-1610	6	552-373	24	685-127	62	919-70	31	FM11-1	89	J12-1224	63
158-1	71	293-752	18	552D-114	27	685-182	62	919-1604	31	FM11-2	89	J13-1223	54
158-1028	73	304-126	43	552D-195	27	685-217	62	919-1604B	31	FM12-1	100	J13-1224	54
158-1084	72	304-127	43	552C-114	26	685-221	62	919-1605	31	FM12-2	100	J13-966	54
158-115	72	304-566	43	552C-195	26	686M-565	52	919-1605B	31	FM14-1	90	S16-1223	5
158-118	73	400-954	10	552B-1606	25	690-182	39	927-252	17	FM15-1	97	S16-966	5
158-126	73	400-956	10	552B-1607	25	690-198	39	947-565	4	FM15-2	97	S18-1223	28
158-127	73	400-958	10	552B-1608	25	696-182	29	947-566	4	FM16-1	106	S18-1224	28
158-281	73	413-182	15	552B-1609	25	696-401	29	947-954	4	FM16-2	106	S18-966	28
158-3	71	413-494	14	553-114	49	807-1	56	947-956	4	FM17-1	96	S26-70	13
158-4	71	413-565	14	553-1153	49	807-1223	57	978-565	32	FM17-2	96	S26-1604B	13
158-5	71	413-566	14	553-195	49	807-18D	59	978-566	32	FM18-1	101	S26-1605B	13
158-54	72	413-919	14	553-373	49	807-19D	59	980-565	7	FM18-2	101		
158-55	70	413-1606	16	556-2	50	807-2	56	980-566	7	FM18-3	101		

