



 *Fabello Decor*®



2016

Лепные украшения из полиуретана

Есть такие вещи, без которых в доме не обойтись! Сантехника, бытовая техника, мебель. А есть то, что превращает помещение, в котором мы живем, в апартаменты. Если Вам приелась безликая непритязательность окружающей обстановки и Вы давно мечтаете о чем-нибудь гораздо более выразительном и стильном, то этот путеводитель для Вас.

Римская классика, классицизм, барокко, модерн - предстанут перед Вами в более чем 500 элементах лепного декора. Из современных коллекций лепнины, только производитель Fabello Decor может предложить покупателю такое многообразие и богатство ассортимента. Fabello Decor - самая крупная коллекция лепных украшений на мировом рынке.

Коллекция Fabello Decor - это лепнина из вспененного полиуретана, современного материала, пришедшего на смену гипсу и алебастру. Вспененный полиуретан был изобретен в России в 30 годы XX века, а в 60 - этот синтетический материал получил широкое распространение в Европе.

Легкую, но при этом столь же пластичную, как гипсовая, полиуретановую массу заливают в специально выточенные металлические формы, в результате чего получают изделия малого веса с прекрасно очерченным рельефом рисунка.

Прочный, экологически чистый, легкий полиуретан делает лепной декор максимально приспособленным для украшения интерьера любой сложности. Лепнина не желтеет со временем, не осыпается, не растрескивается, не теряет четкости рельефа, не собирает пыль. Ее можно подвергать влажной уборке. В отличие от мягкого полистирола, который также используется в производстве лепных украшений, она при любых условиях сохраняет форму.

Современный дизайн избегает однообразия, пусть даже классического. Традиционно белые лепные украшения сегодня все чаще подвергают той или иной покраске. Благодаря специальной грунтовке, поверхность декора Fabello Decor изначально подготовлена к ней. Для этой цели можно использовать любые вододисперсионные, акриловые, масляные краски.

Монтаж декоративных лепных украшений Fabello Decor достаточно прост, и может быть осуществлен домашним мастером.

Коллекция Fabello Decor включает в себя весь спектр декоративной лепнины, необходимый для воплощения законченного и гармоничного замысла. Это богатейший набор карнизов для оформления стыков стен и потолка, молдинги для украшения стен и потолка, розетки, оформляющие пространство вокруг люстры, пилястры, колонны, пьедесталы, а также множество других декоративных элементов, чья уместность в интерьере проверена временем.

С помощью лепного декора Fabello Decor можно воссоздать любую, историческую эпоху в отдельно взятом пространстве или сконструировать собственный новомодный стиль в духе современного эклектизма. Магическому очарованию классических форм найдется место в любой обстановке.

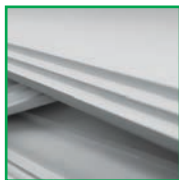

Карнизы с гладким профилем
4



Карнизы с орнаментом
10



Молдинги
19



Угловые элементы
27



Круговые бордюры
30



Потолочные розетки
32



Кессоны
38



Орнаменты
40



Консоли
42



Обрамление порталов
44



Пилястры
46



Колонны
50



Пьедесталы
56



Настенное панно
57



Обрамление дверных проемов
65



Ниши
69



Купола
72

Инструкция по монтажу лепного декора из полиуретана



1. Сделайте отметки карандашом на стене, чтобы определить местоположение карниза.



2. Используя ножовку, отрежьте карниз под углом 45 градусов.



3. Нанесите клей вдоль по краям обратной стороны карниза, а также на поверхность, которую будете клеить.



4. Соедините оба карниза вместе, чтобы их профили совпадали. Используйте специальный клей для стыковки изделий.



5. Перед тем как забить гвозди, убедитесь в ровности соединения.



6. С помощью ножика для замазки швов обработайте стыки карнизов.



7. Для шлифовки поверхности используйте наждачную бумагу.



8. Закройте стены и потолок тейп-лентой. Используя кисточку, покройте краской карниз.

Перед установкой элементов лепнины необходимо, чтобы изделия были адаптированы к помещению. Для этого следует их оставить на 24 часа в данном помещении.

Предварительно следует убедиться, что стены и потолок в местах монтажа лепнины сухие и чистые, для более надежной склейки их с полиуретаном.

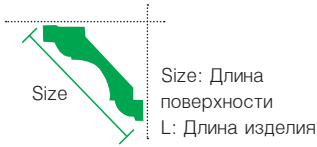

Карнизы - выступающие элементы внутренней и внешней отделки зданий, помещений, мебели. В архитектуре карниз отделяет плоскость крыши от вертикальной плоскости стены по выделенным горизонтальными линиями. Карниз из полиуретана - декоративный элемент, соединяющий шов между потолком и стенами.

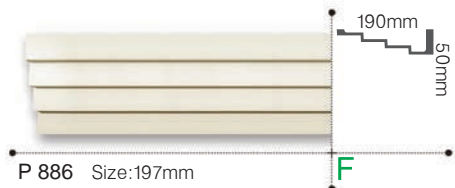
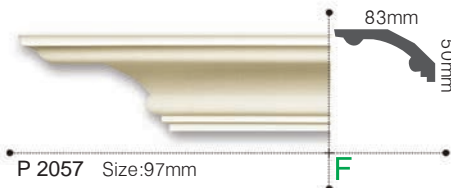
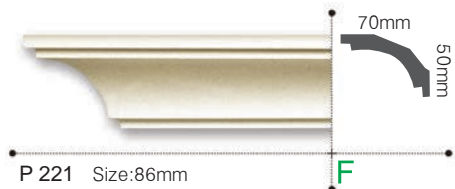
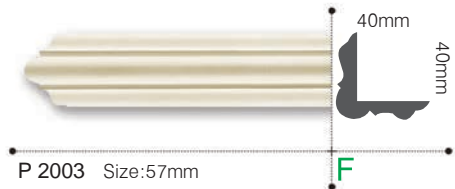

Карнизы с гладким профилем

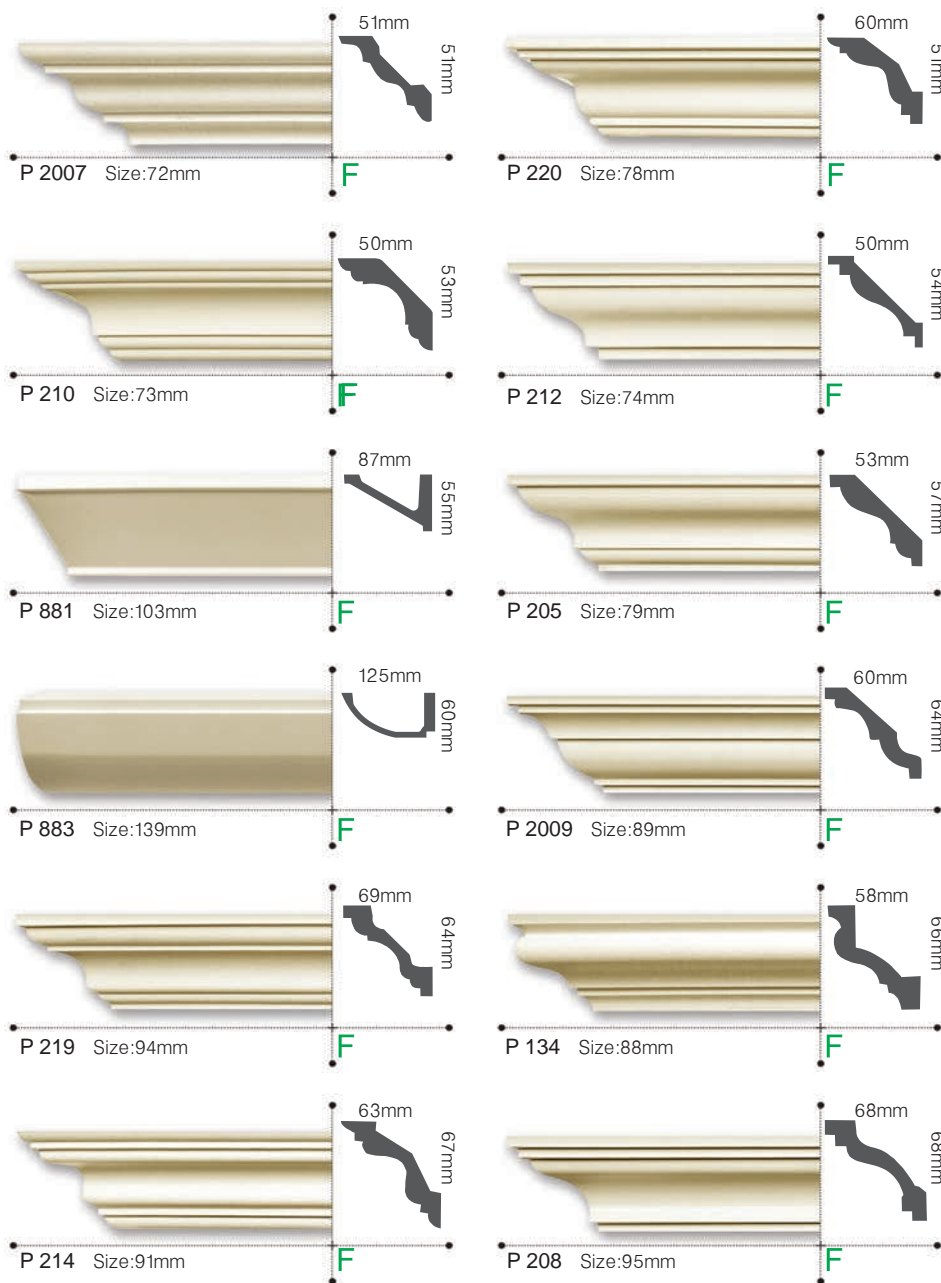

F - элемент имеет гибкий аналог

*длина элементов 2440mm

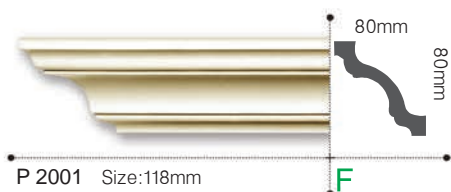
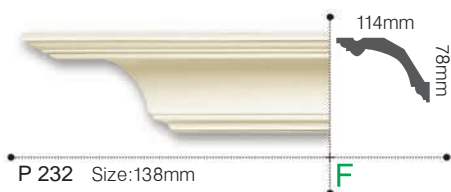
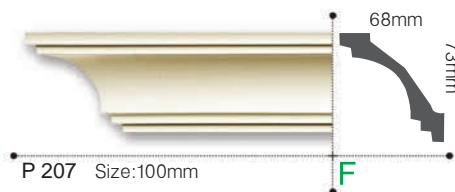
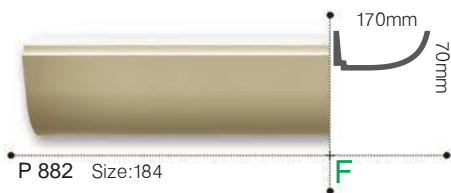
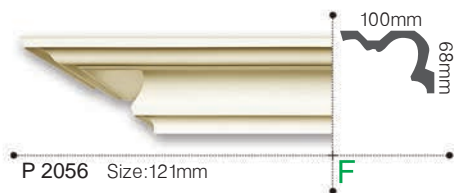

Карнизы с гладким профилем

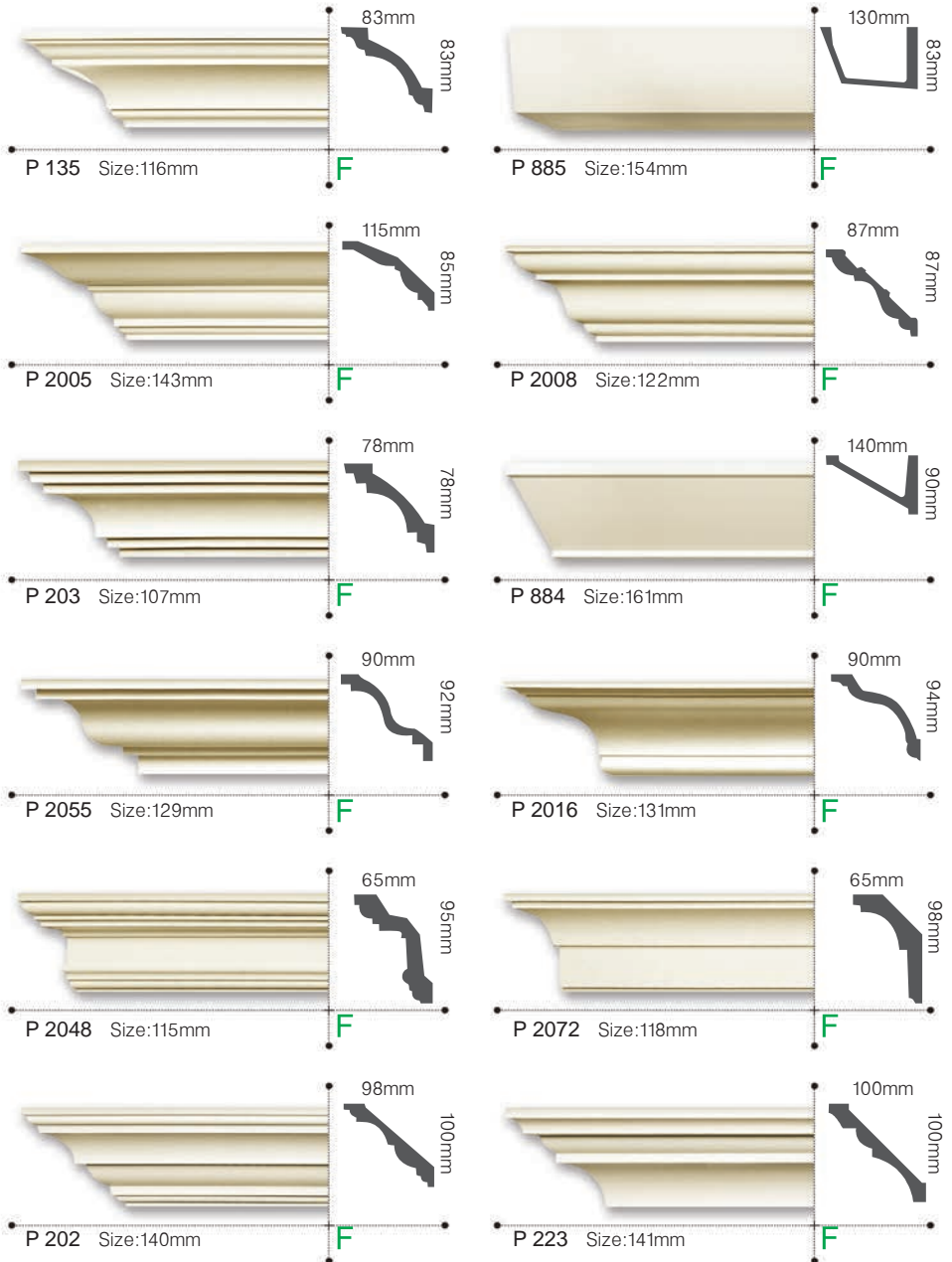

F - элемент имеет гибкий аналог

*длина элементов 2440mm

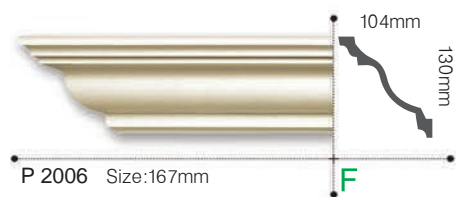
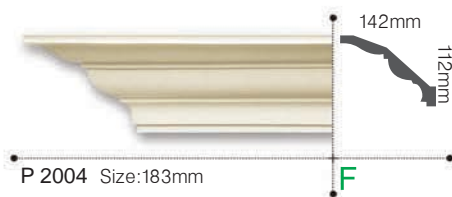
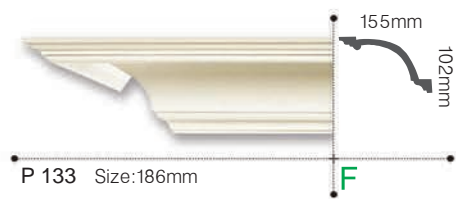

Карнизы с гладким профилем

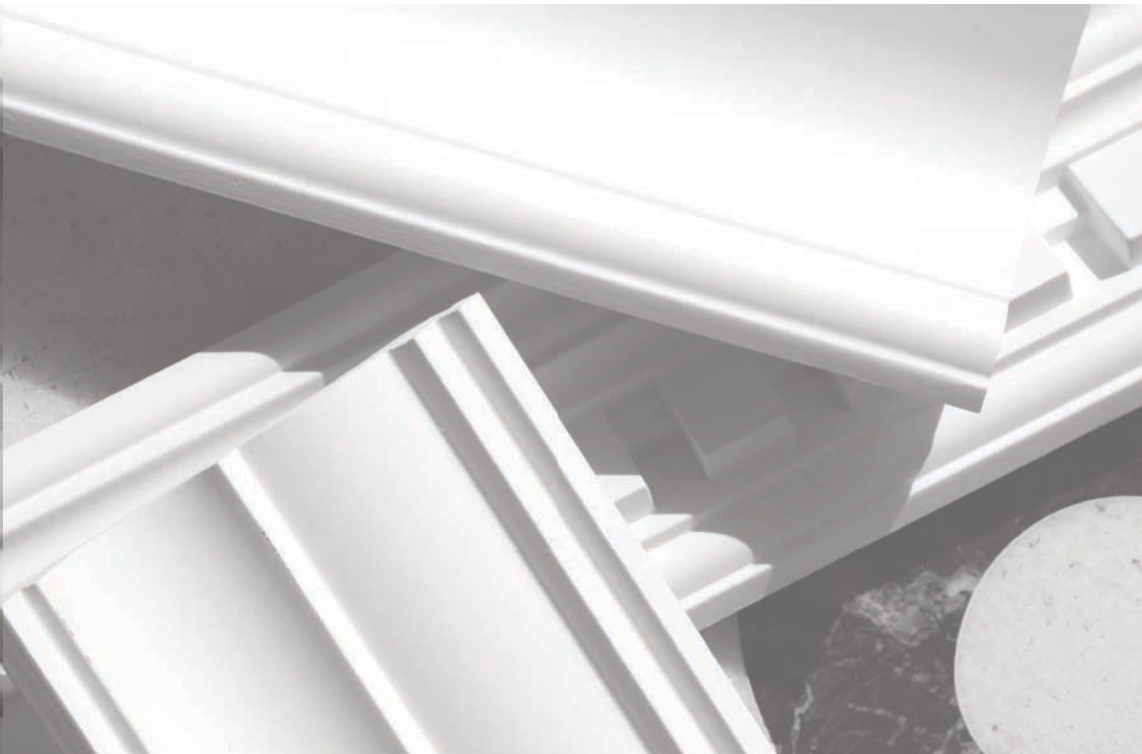
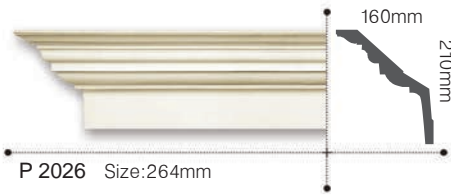
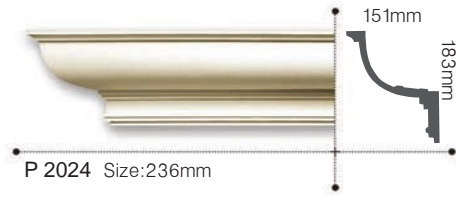
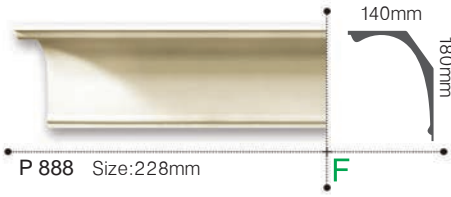
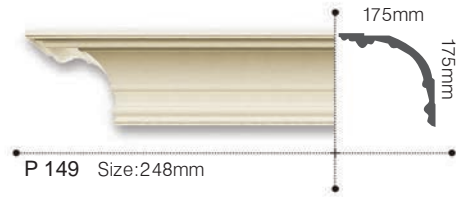
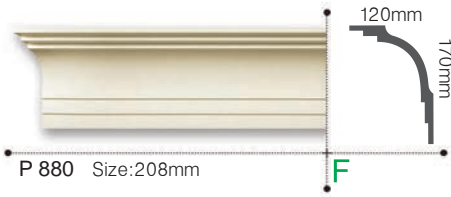

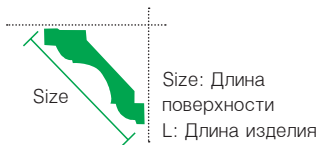

Карнизы не только оформляют периметр потолка, но и скрывают возможные неровности стыка потолка и стен. Каждый вид карниза или группа орнаментов позволяют создавать особое стилевое решение. Возможны комбинации карнизов гладких и с орнаментом. Их прочность гарантирует долгую службу, а возможность покраски поможет им удачно вписаться в интерьер.

В коллекции "Gaudi Decor" - обширный ассортимент карнизов с различными видами орнаментов.



C 1041 Size:70mm



C 1090 Size:76mm



C 161 Size:79mm

F



C 1005 Size:85mm

F



C 1085 Size:87mm

F



C 147 Size:71mm

F



C 1016 Size:86mm

F



C 1003 Size:78mm



C 129 Size:76mm

F



C 1008 Size:89mm

F

Карнизы с орнаментом



C 1044 Size:97mm

F



C 1084 Size:106mm

F



C 173 Size:101mm

F



C 1014 Size:88mm

F



C 1113 Size:103mm

F



C 176 Size:103mm

F



C 1079 Size:122mm

F



C 141 Size:83mm

F



C 128 Size:89mm

F



C 144 Size:129mm

F



C 152 Size:109mm

F



C 1001 Size:94mm

F

F - элемент имеет гибкий аналог

*длина элементов 2440mm

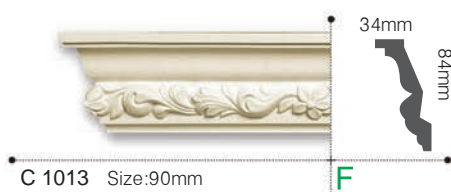
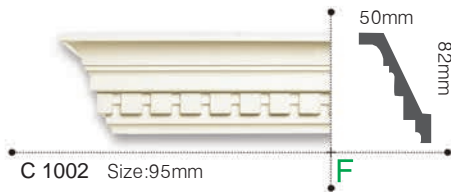
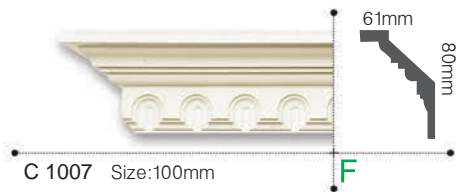

Карнизы с орнаментом

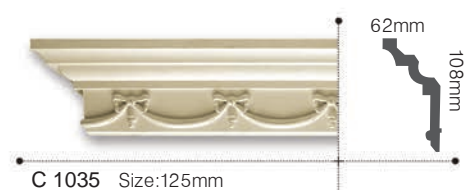
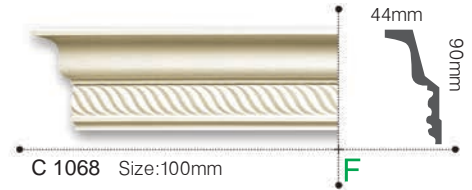
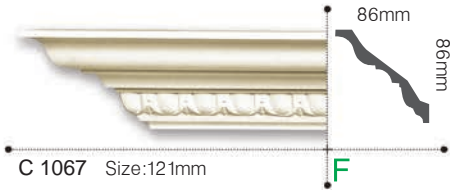

F - элемент имеет гибкий аналог

*длина элементов 2440mm

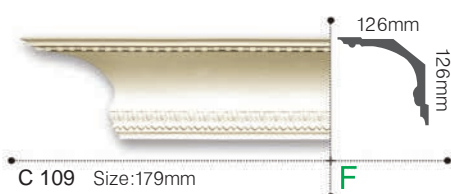
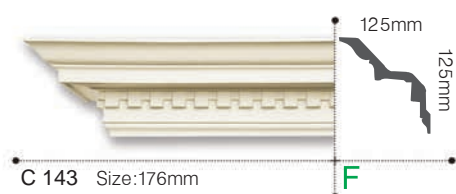
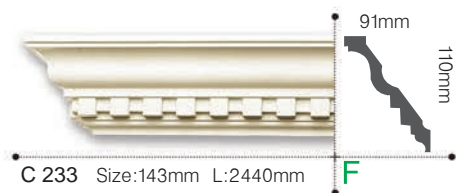
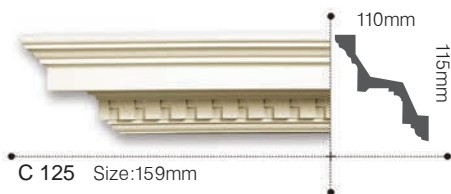

Карнизы с орнаментом







P 149 175x175mm



P 149 175x175mm



C 156 175x175mm

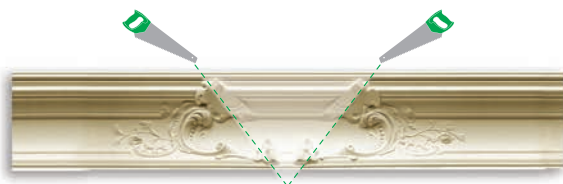

C 156 175x175mm



C 156 175x175mm



P 149 175x175mm

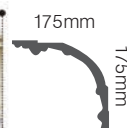

C 150 175x175mm



1210mm



C 156 175x175mm



410mm

*длина элементов 2440mm

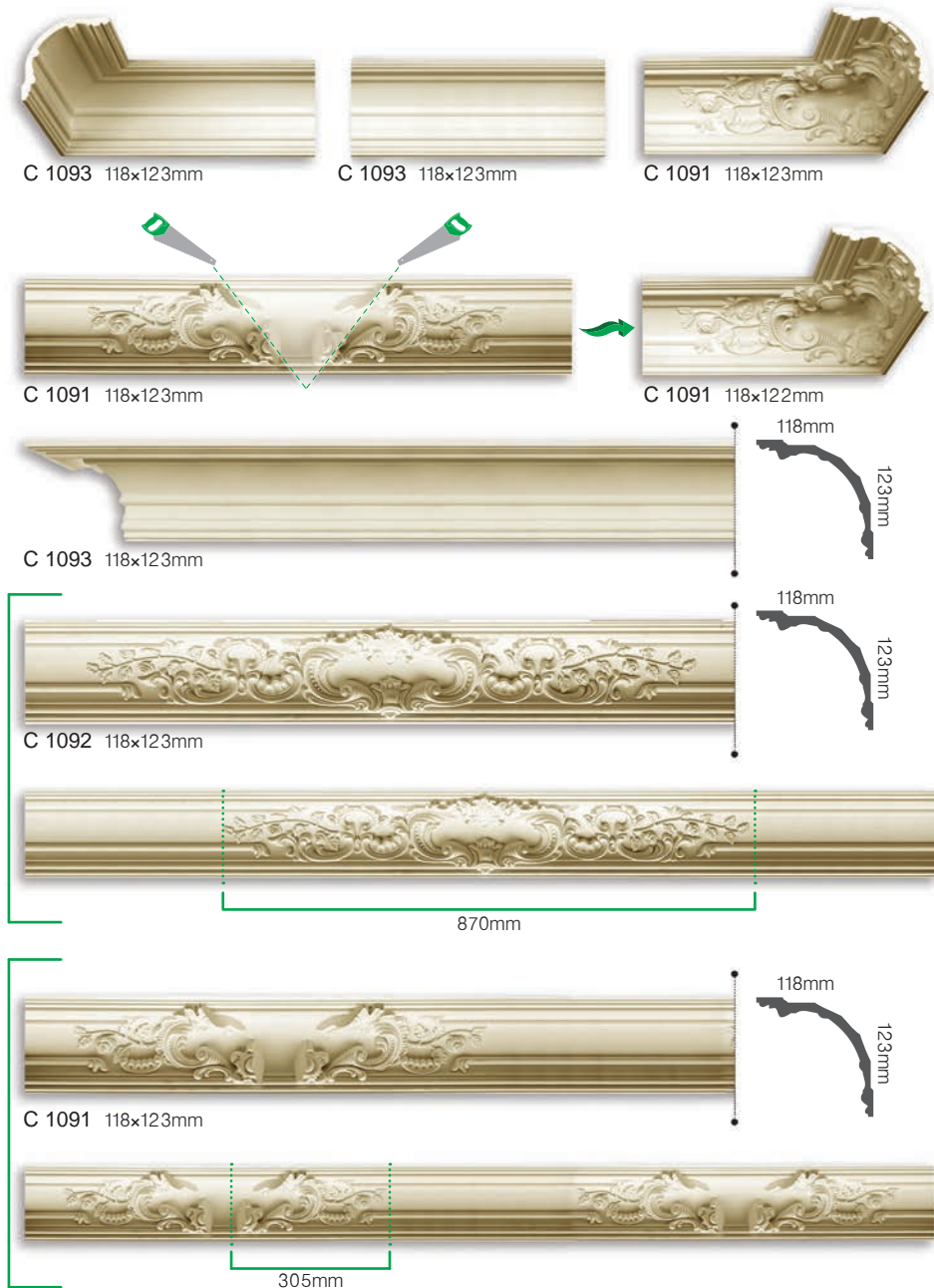

SIZE: Длина
L: поверхности
Длина изделия



Молдинги

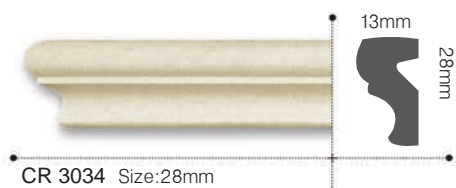
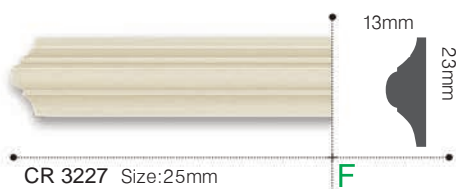
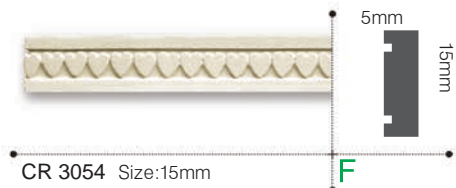

F - элемент имеет гибкий аналог

*длина элементов 2440mm

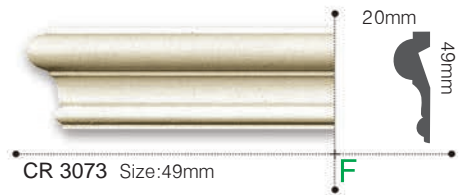
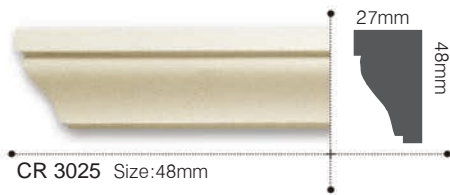
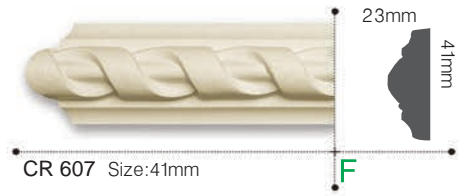



CR 3007 Size:54mm

F



CR 3022 Size:55mm



CR 3023 Size:55mm



CR 405 Size:55mm

F



CR 601 Size:55mm



CR 3057 Size:57mm

F



CR 683 Size:57mm

F



CR 642 Size:61mm

F



CR 689 Size:62mm

F



CR 622 Size:65mm



CR 688 Size:65mm

F



CR 3006 Size:68mm

F

F - элемент имеет гибкий аналог

*длина элементов 2440mm



CR 3059 Size:68mm



CR 402 Size:69mm

F



CR 404 Size:69mm

F



CR 639 Size:75mm

F ●



CR 3079 Size:76mm

F



CR 644 Size:76mm

F



CR 602 Size:77mm

F



CR 154 Size:80mm

F



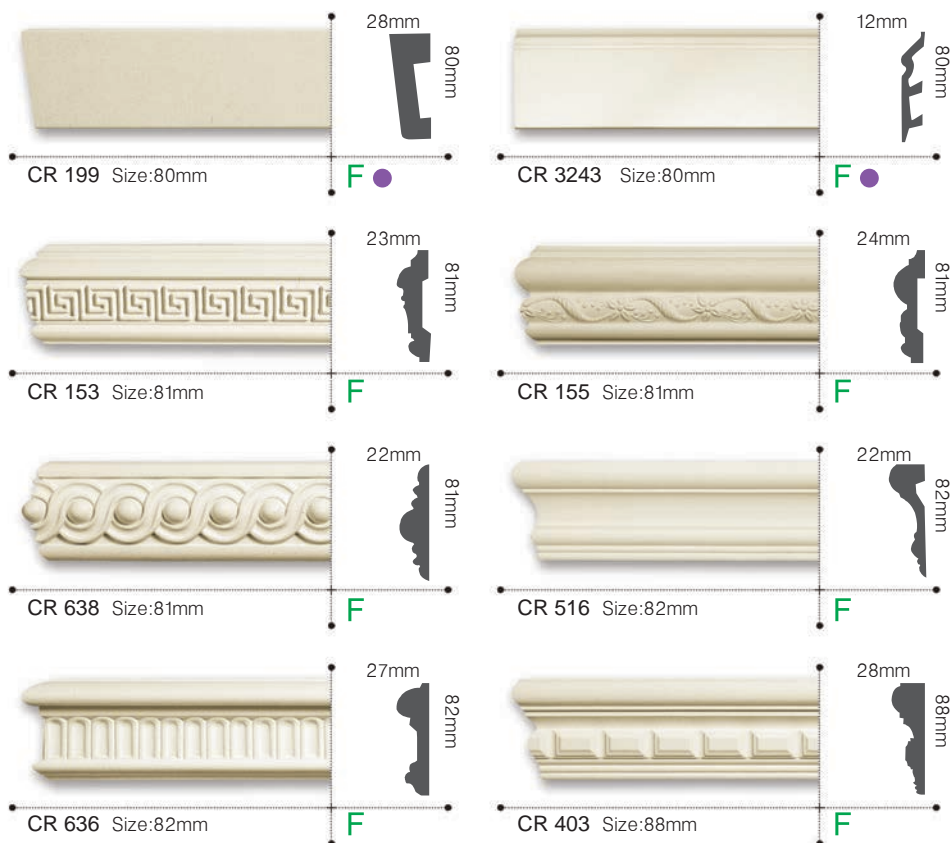

● - может использоваться как декоративный плинтус
 F - элемент имеет гибкий аналог

*длина элементов 2440mm

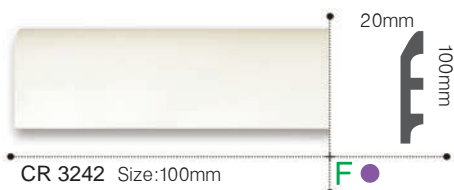



CR 632 Size:110mm

F



CR 3241 Size:120mm

F ●



CR 3043 Size:124mm

F ●



CR 646 Size:126mm

F



CR 608 Size:138mm

F



CR 3245 Size:141mm

F



CR 200 Size:140mm

F ●



CR 3246 Size:160mm

F

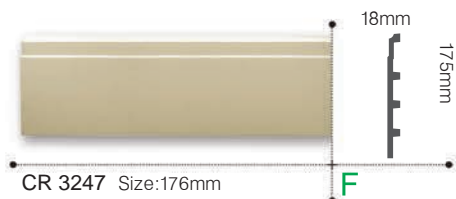

Угловые элементы

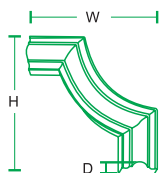

Угловые элементы и бордюры обычно используют для оформления плоскости потолка или стен определенным рельефом или узором. Оформленные таким образом стены или потолок приобретают изящные формы.

Лучшие образцы архитектуры элементов декора от древнегреческой классики до модерна используются для придания интерьерам насыщенной и завершенной композиции.

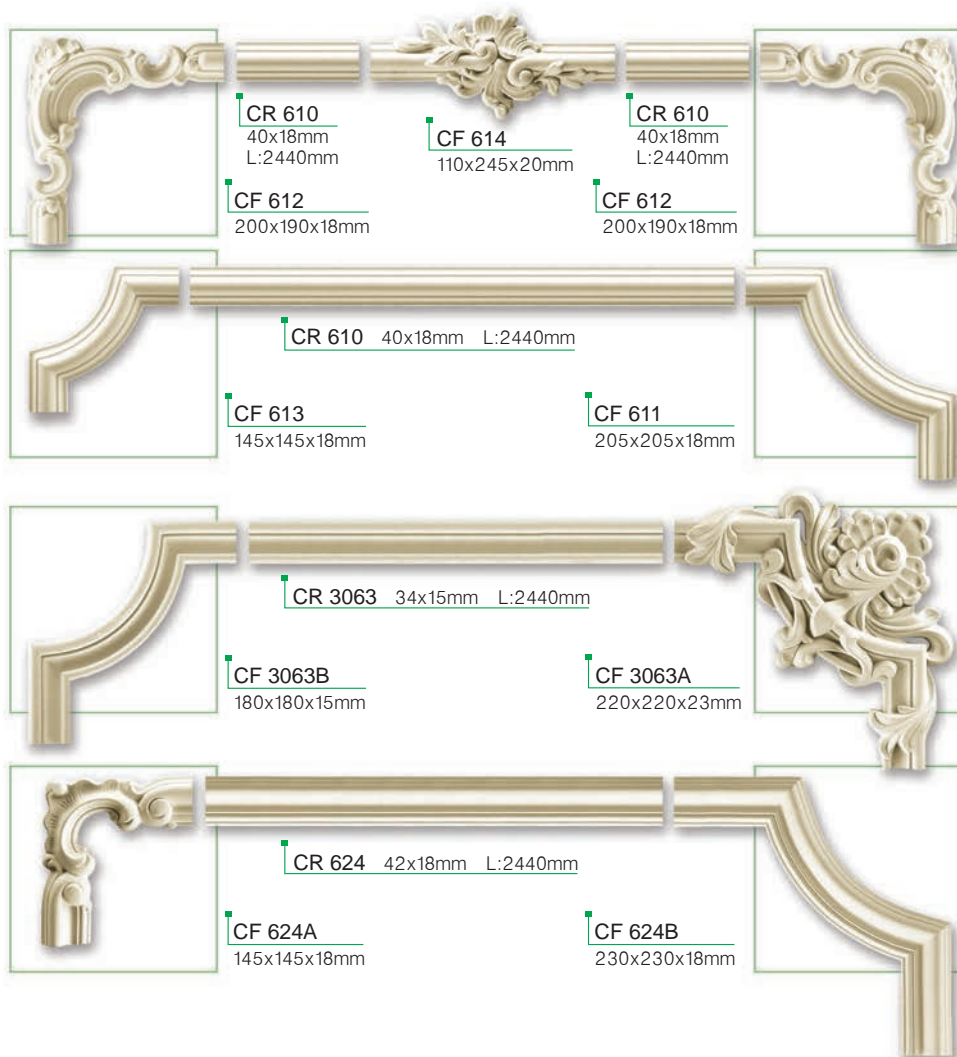

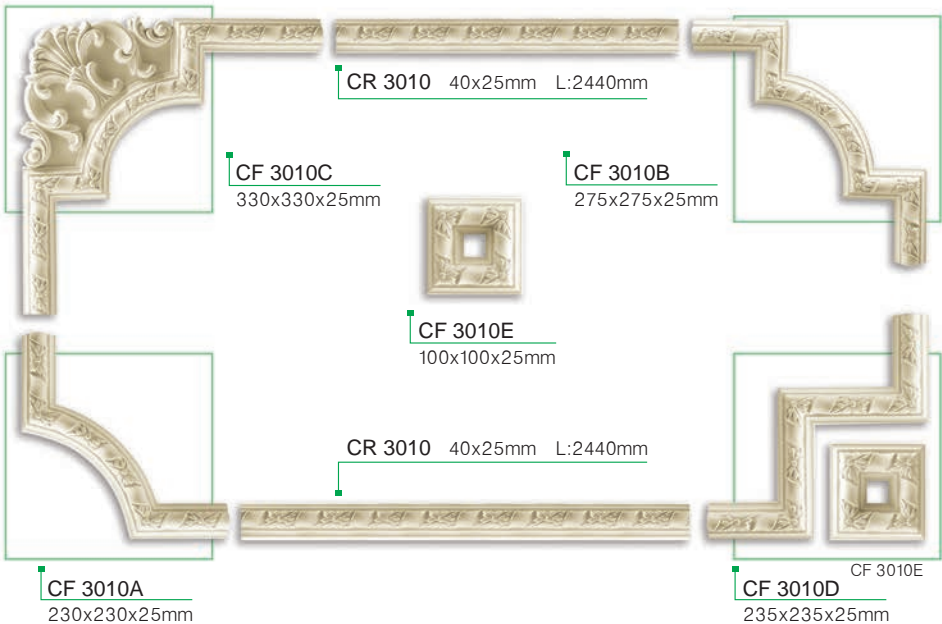
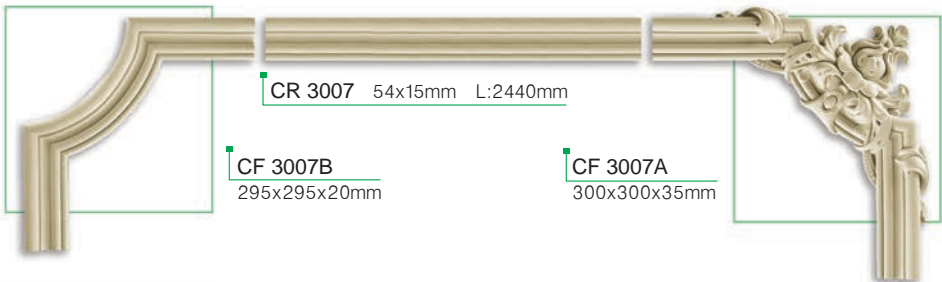
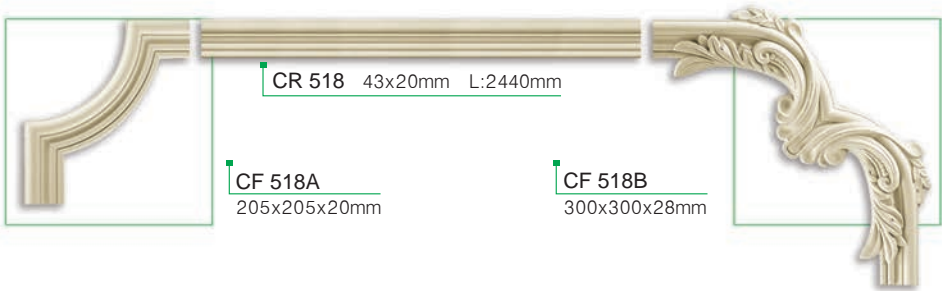

Угловые элементы

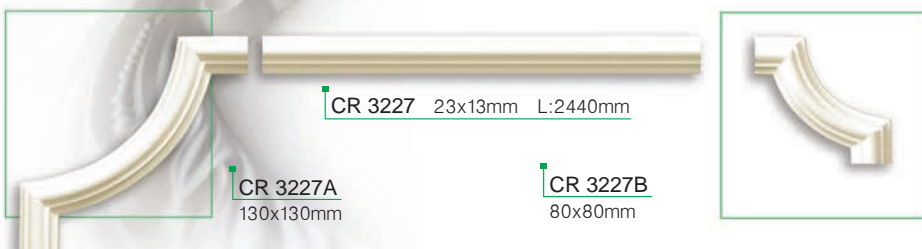
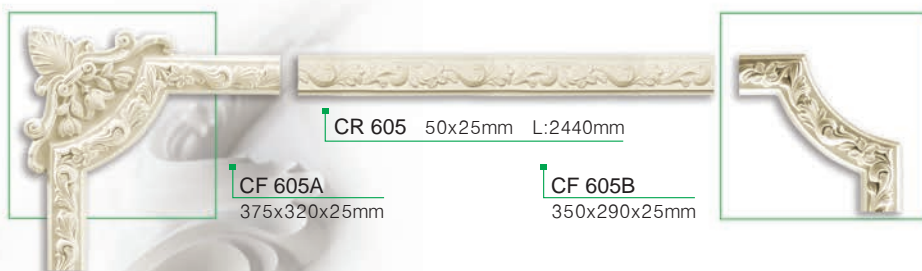
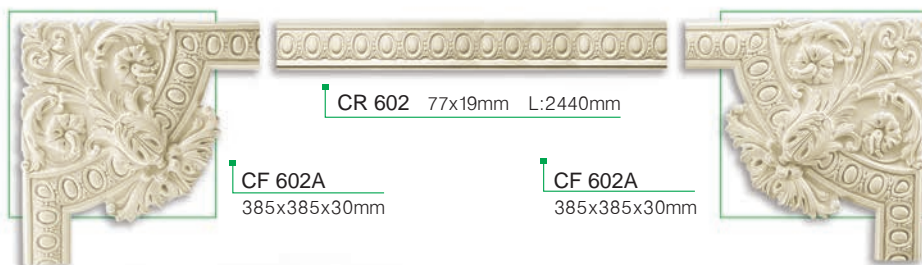

Круговые бордюры - изогнутые молдинги, которые используются для обрамления арочных проемов, нишевых пространств, оформления потолков, создания круговых рамок. С некоторыми из бордюров стыкуются молдинги.

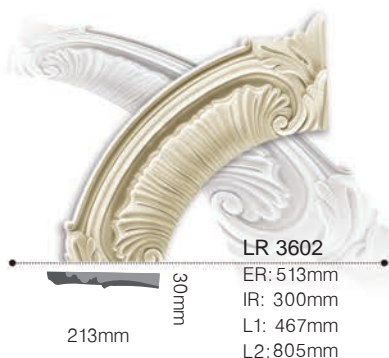
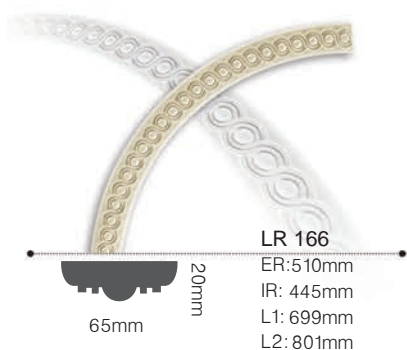
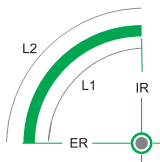
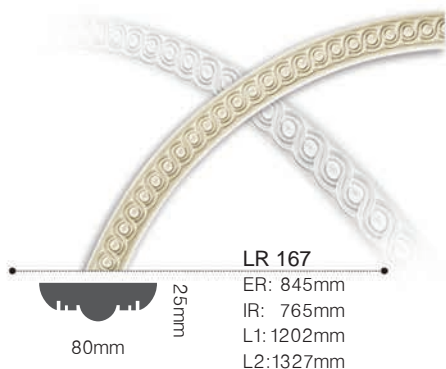

Круговые бордюры



LR 3073/50	LR 3073/65
ER: 547mm	ER: 697mm
IR: 500mm	IR: 650mm
L1: 785mm	L1: 1021mm
L2: 859mm	L2: 1095mm



LR 3073F(R)/50

LR 3073F(R)/65
105x50x27mm

LR 3073F(L)/50

LR 3073F(L)/65
105x50x27mm



LR 3073R/50

LR 3073R/65
105x50x27mm



CR 3073 Size:49mm L:2440mm

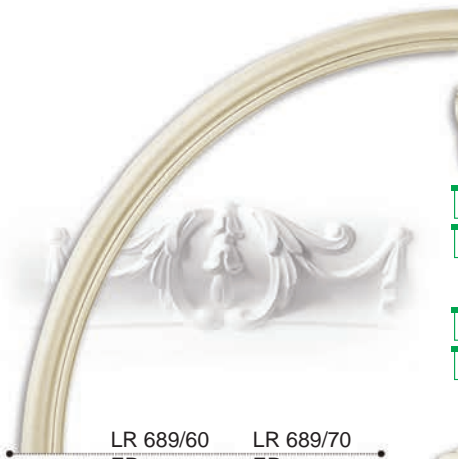

LR 689/60	LR 689/70
ER: 662mm	ER: 762mm
IR: 600mm	IR: 700mm
L1: 942mm	L1: 1099mm
L2: 1039mm	L2: 1197mm



LR 689F(R)/60

LR 689F(R)/70
105x50x27mm

LR 689F(L)/60

LR 689F(L)/70
105x50x27mm



LR 689R/60

LR 689R/70
105x50x27mm



CR 689 Size:62mm L:2440mm

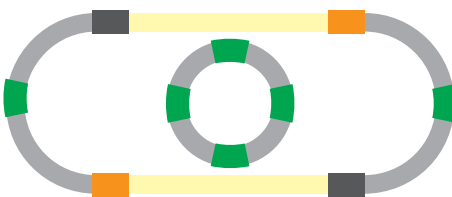

LR 3073 ● LR 689

LR 3073/50 LR 3073/65 ● LR 689/60 LR 689/70

LR 3073R/50 LR 3073R/65 ● LR 689R/60 LR 689R/70

LR 3073F(L)/50 LR 3073F(L)/65 ● LR 689F(L)/60 LR 689F(L)/70

LR 3073F(R)/50 LR 3073F(R)/65 ● LR 689F(R)/60 LR 689F(R)/70

Традиционно потолочные розетки составляют центральную часть композиции потолка и оформляют пространство вокруг люстры.

Сегодня некоторые дизайнеры используют их в качестве орнамента на потолке или стене. Вместе с подобранными молдингами и карнизами придают потолку законченный вид.



R 4015
 ∅ 200mm
 H: 40mm



R 316
 ∅ 300mm
 H: 35mm



R 4016
 ∅ 300mm
 H: 32mm



R 371
 305x435mm
 H: 38mm



R 314
 315x600mm
 H: 45mm



R 318
 ∅ 335mm
 H: 45mm



R 312
 ∅ 400mm
 H: 32mm



R 4017
 ∅ 400mm
 H: 36mm



R 4030
 ∅ 400mm
 H: 45mm



R 4032
⌀ 400mm
H: 42mm



R 4033
⌀ 400mm
H: 49mm



R 350
⌀ 410mm
H: 24mm



R 303
⌀ 415mm
H: 45mm



R 4025
⌀ 430mm
H: 22mm



R 311
⌀ 435mm
H: 44mm



R 4037
⌀ 450mm
⌀ 100mm
H: 41mm



R 304
⌀ 460mm
H: 25mm



R 347
⌀ 460mm
H: 45mm



R 349
⌀ 460mm
H: 36mm



R 4012
⌀ 475mm
H: 48mm



R 4038
⌀ 478mm
⌀ 100mm
H: 50mm



R 313
⌀ 482mm
H: 35mm



R 309
⌀ 495mm
H: 58mm



R 4022
⌀ 500mm
H: 55mm



R 4019
500x800mm
H: 31mm



R 310
⌀ 515mm
H: 32mm



R 4029
Ø 520mm
H: 35mm



R 345
Ø 525mm
H: 29mm



R 4031
Ø 540mm
H: 50mm



R 317
Ø 560mm
H: 55mm



R 348
Ø 575mm
H: 27mm



R 4039
Ø 596mm
⊙ 100mm
H: 48mm



R 306
Ø 600mm
H: 46mm



R 4023
Ø 600mm
H: 31mm



R 301
Ø 605mm
H: 71mm



R 305

Ø 660mm

H: 65mm



R 4006

Ø 665mm

H: 65mm



R 336

Ø 667mm

H: 20mm



R 337

Ø 670mm

H: 55mm



R 338

Ø 687mm

H: 51mm



R 4024

Ø 720mm

H: 61mm



R 361

730x1080mm

H: 25mm

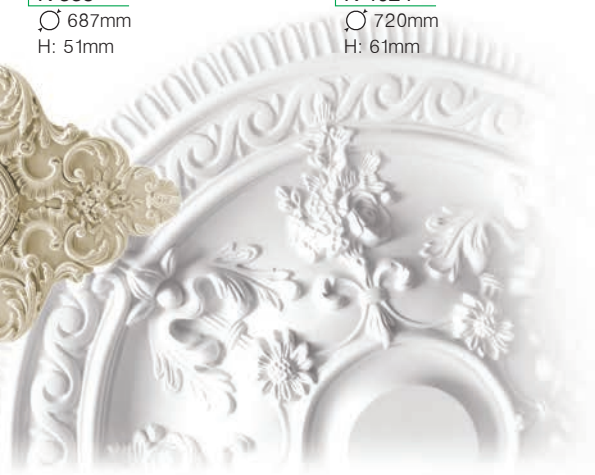



R 335
Ø 738mm
H: 49mm



R 308
Ø 760mm
H: 45mm



R 120
Ø 770mm
H: 41mm



R 307
Ø 830mm
H: 52mm



R 302
Ø 968mm
H: 79mm



R 4007
Ø 1010mm
H: 65mm

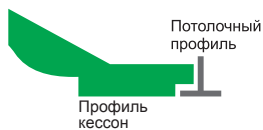

Кессоны - это квадратные или многоугольные углубления на потолке или внутренней поверхности арки, свода или потолка. Кессоны играют конструктивную роль, а также применяются для улучшения акустики помещений. Кессоны монтируются в подвесной гипсокартонный потолок и традиционно используются группой.



R 4009
600×600×41mm



R 4010
598×598×40mm



R 4013
598×598×48mm



R 4014
598×598×78mm



R 4041
598×598×78mm



R 4042
598×598×78mm



R 4043
598×598×84mm



R 4044
598×598×72mm



R 4045
598×598×76mm



R 4046
598×598×78mm



R 4047
598×598×78mm



R 4048
598×598×79mm



R 4049
598×598×78mm



R 4050
598×598×44mm



A 620
Ø 60×10mm



A 373
Ø 63×10mm

Многие дизайнеры используют эти украшения на основе сочетания, комбинации, для создания более богатых, наполненных жизнью эффектов и эстетики.

Ощутите удивительную разницу, используя немного воображения.



A 621
65×65×8mm



A 320
Ø 80×13mm



A 328
89×89×12mm



A 118
95×80×40mm



A 319
Ø 95×15mm



A 324
100×100×20mm



A 989
130×125×20mm



A 322
Ø 155×30mm



A 372
Ø 160×16mm



A 321
Ø 165×25mm



A 323
Ø 210×25mm



A 370
Ø 225×38mm



AW 6020L AW 6020R
125×40×9mm 125×40×9mm



AW 6039L AW 6039R
124×95×13mm 124×95×13mm



AW 6027L AW 6027R
125×80×13mm 125×80×13mm



AW 6074L AW 6074R
295×135×16mm 295×135×16mm



AW 6111L AW 6111R
260×126×15mm 260×126×15mm



AW 6018L AW 6018R
170×50×14mm 170×50×14mm



AW 6051
225×570×30mm



AW 6077
80×52×15mm



AW 6012
73×296×14mm



AW 6071
67×215×15mm



AW 6063
120×615×15mm



Консоли обычно используют для увеличения привлекательности колонн и потолочных участков. С их помощью завершают дизайнерское оформление на основе иллюзии дерева, гранита. Возможно также использование консолей в качестве полок и опор.



B 824
109×88×43mm



B 972
128×73×35mm



B 821
140×115×70mm



B 823
141×101×65mm



B 822
143×107×67mm



B 827M
152×100×54mm



B 837
168×109×60mm



B 964
168×114×70mm



B 978
185×77×151mm



B 960
189×116×85mm



B 966
191×185×98mm



B 965
206×91×76mm



B 957
212×120×47mm



B 835
220×130×94mm



B 813
223×182×84mm



B 976
238×88×58mm



B 962
250×168×122mm



B 959
253×127×51mm



B 816
265×172×83mm



B 815
269×156×55mm



B 859
715×145×215mm



B 961
281×246×199mm



B 814
282×159×67mm



B 971
301×171×145mm



B 977
310×130×75mm



B 963
314×143×145mm



B 979
325×114×108mm



B 857
382×209×132mm

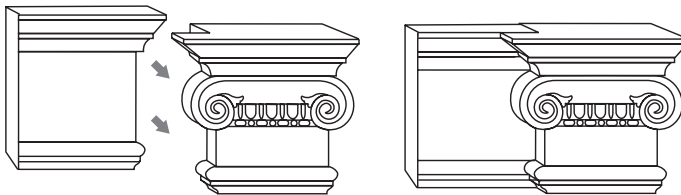
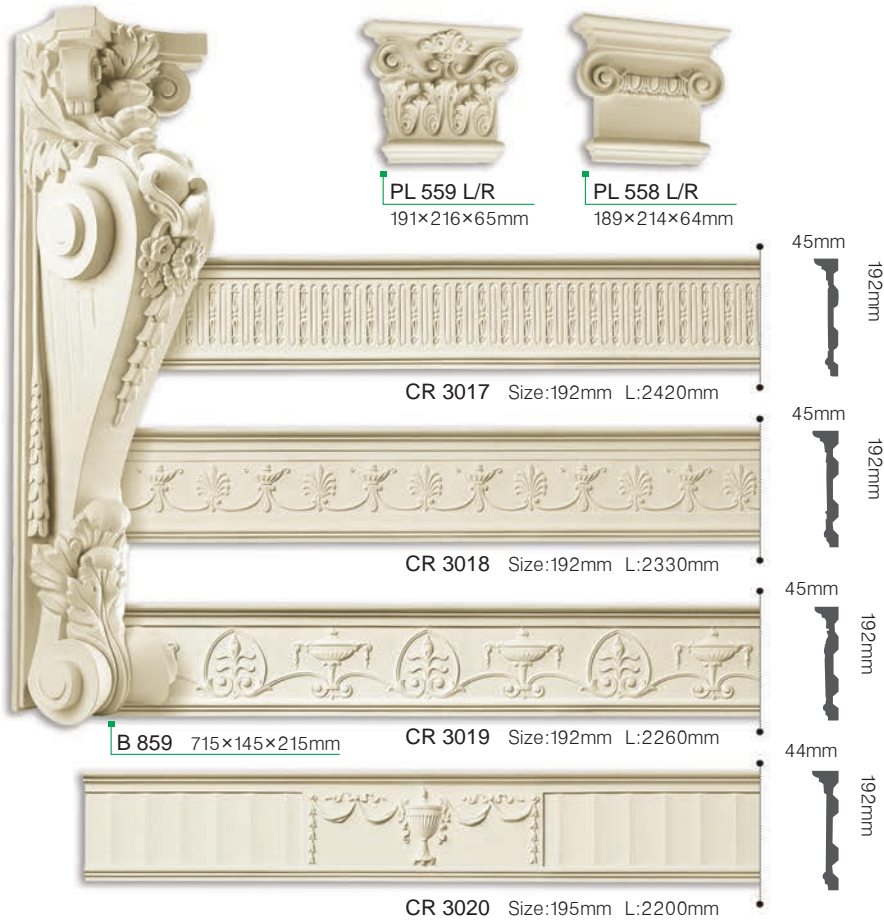



PL 559L + CR 3017 + PL 559R



PL 559L + CR 3018 + PL 559R



PL 558L + CR 3019 + PL 558R



PL 558L + CR 3020 + PL 558R

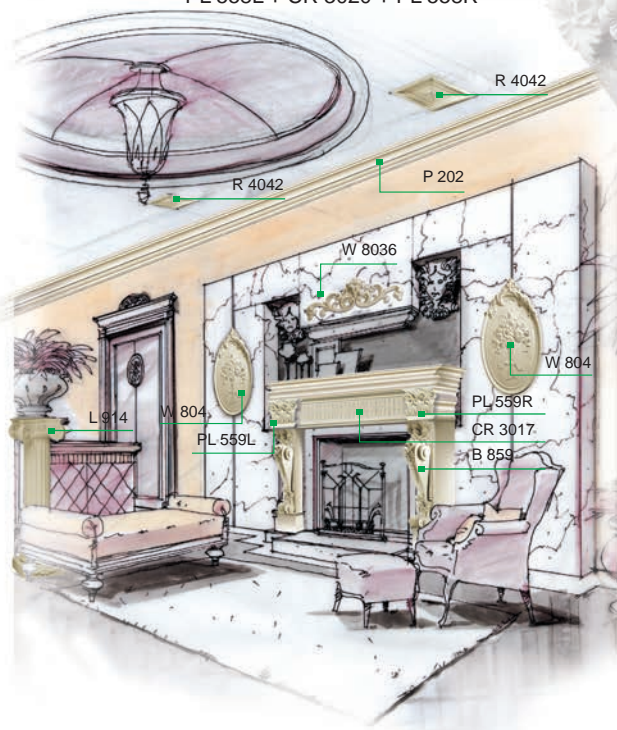

Капитель		PL 558 L/R				
		PL 559 L/R			PL 564	
		PL 554	PL 561	PL 564	PL 565	
	PL 551	PL 562	PL 563	PL 565	PL 567	PL 557
Тело	PL 550	PL 553	PL 573	PL 575	PL 576	PL 553x2
База	PL 552	PL 555	PL 574	PL 566	PL 566	PL 555x2

Пилястры предназначены для вертикального разделения плоскости на функциональные зоны. Могут использоваться парами в обрамлении дверей. При помощи пилястр можно избавиться от скучного, однообразного вида стены.

PL 557
345×419×95mm

PL 551
163×178×45mm



PL 554
145×225×50mm



PL 562
80×242×70mm



PL 550
110×20mm
2000mm

PL 553
135×20mm
2000mm

PL 553x2
135×2×20mm
2000mm

PL 552
255×110×30mm
E: 2418mm

PL 555
255×135×30mm
E: 2400mm

PL 555x2
255×135×2×30mm
E: 2335mm

PL 555x2
255×135×2×30mm
E: 2600mm

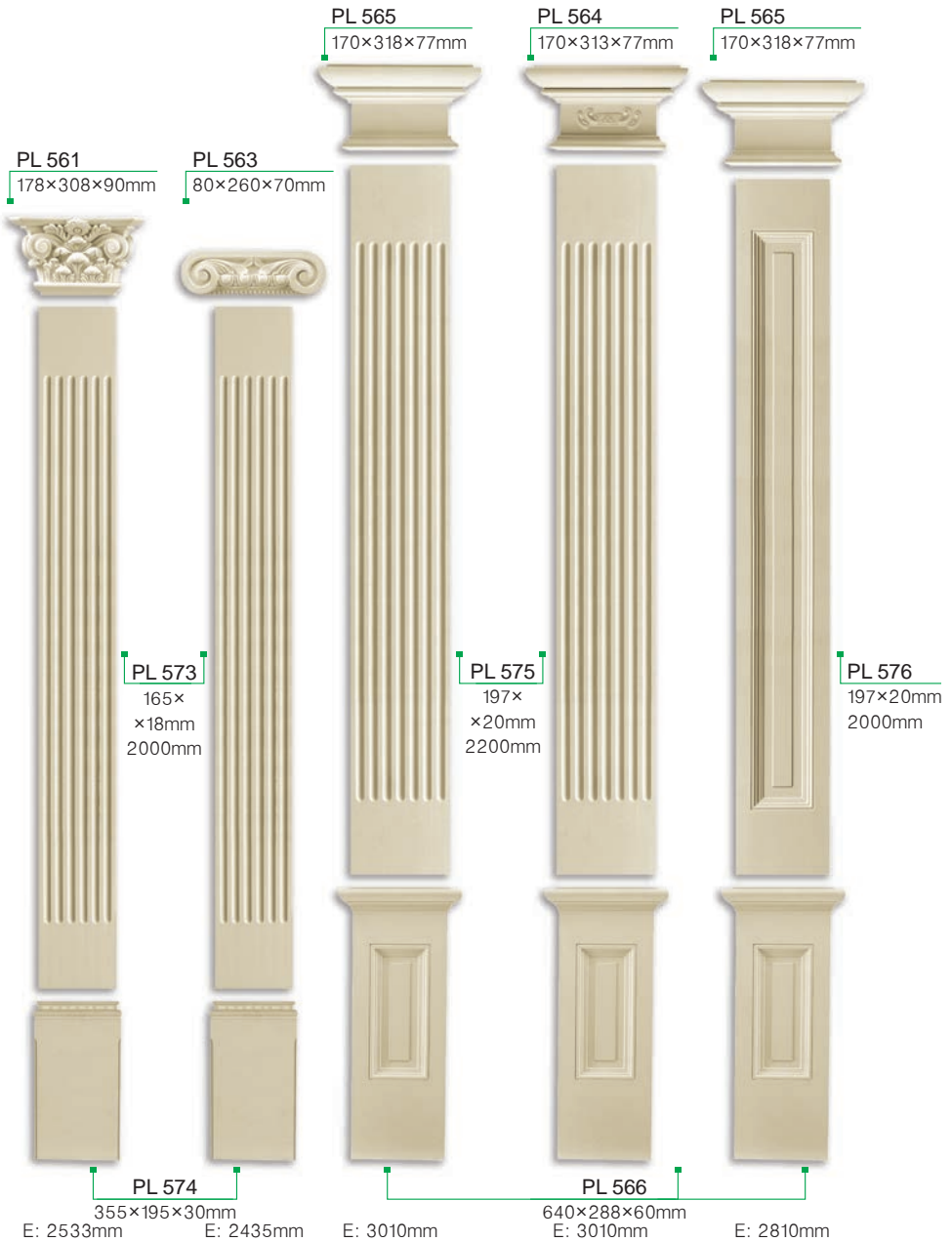

E - общая высота в сборе

PL 564

170×313×77mm



PL 567

212×212×30mm



PL 558 L/R

189×214×64mm



PL 559 L/R

191×216×65mm



PL 576

2000×197×20mm

PL 553

2000×135×20mm

PL 566

640×288×60mm

PL 555

255×135×30mm

E: 2810mm

E: 2852mm

E: 2444mm

E: 2446mm

E - общая высота в сборе



CR 3017 Size:192mm L:2420mm



CR 3018 Size:192mm L:2330mm



CR 3019 Size:192mm L:2260mm



CR 3020 Size:195mm L:2200mm



PL 559L + CR 3018 + PL 559R
PL 55342 + PL 55542



PL 559L + CR 3017 + PL 559R



PL 558L + CR 3019 + PL 558R



PL 567 + CR 3019 + PL 567



PL 559 L/R
191×216×65mm



PL 558 L/R
189×214×64mm



PL 567
212×212×30mm



PL 555
255×135×30mm

Колонны используются как опорный элемент карниза, для оформления входа в здание или помещение. Могут быть применены в арочных конструкциях или проемах. Внутри помещения отделяют проходную часть от гостиной. Колонна состоит из капители, тела колонны и базы. Длину тела колонны можно варьировать в зависимости от высоты помещения путем укорачивания или дотачивания необходимой части.

Тело

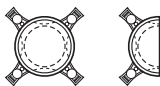
Капитель

Диаметр	Ширина	Высота	●	◐
∅ 120mm	230mm	85mm	L 9311 F	L 9321 H
∅ 150mm	265mm	105mm	L 9313 F	L 9323 H
∅ 180mm	300mm	115mm	L 9315 F	L 9325 H
∅ 200mm	360mm	125mm	L 9317 F	L 9327 H

Капитель

Диаметр	Ширина	Высота	●	◐
∅ 120mm	228mm	155mm	L 9312 F	L 9322 H
∅ 150mm	290mm	207mm	L 9314 F	L 9324 H
∅ 180mm	330mm	245mm	L 9316 F	L 9326 H
∅ 200mm	375mm	257mm	L 9318 F	L 9328 H

База

Диаметр	Ширина	Высота	●	◐
∅ 120mm	200mm	100mm	L 9309 F	L 9309 H
∅ 150mm	240mm	130mm	L 9310 F	L 9310 H
∅ 180mm	280mm	145mm	L 9319 F	L 9319 H
∅ 200mm	310mm	160mm	L 9320 F	L 9320 H

Диаметр	● Рифленая	○ Гладкая
∅ 120mm	L 9301	L 9302
∅ 150mm	L 9303	L 9304
∅ 180mm	L 9305	L 9306
∅ 200mm	L 9307	L 9308
Высота	2395mm	2425mm



L 9311F
L 9321H
85×230mm
⌀ 120mm

L 9301F
L 9301H
2395mm
⌀ 120mm
⌀ 70mm

E: 2580mm

E: 2610mm

L 9302F
L 9302H
2425mm
⌀ 120mm
⌀ 70mm



L 9312F
L 9322H
155×228mm
⌀ 120mm

L 9301F
L 9301H
2395mm
⌀ 120mm
⌀ 70mm

L 9302F
L 9302H
2425mm
⌀ 120mm
⌀ 70mm



L 9309F
L 9309H
100×200mm
⌀ 120mm

L 9309F
L 9309H
100×200mm
⌀ 120mm

E: 2650mm

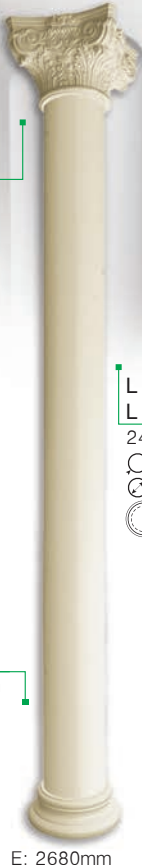

E: 2680mm





L 9313F
L 9323H
105×265mm
Ø 150mm

L 9303F
L 9303H
2395mm
Ø 150mm
Ø 75mm



L 9310F
L 9310H
130×240mm
Ø 150mm



E: 2630mm

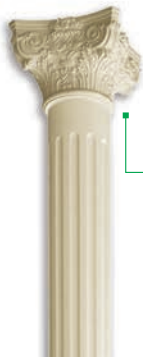

L 9304F
L 9304H
2425mm
Ø 150mm
Ø 75mm



E: 2660mm

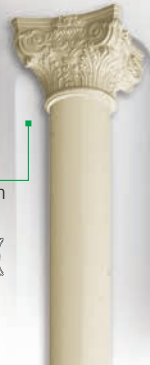

L 9314F
L 9324H
207×290mm
Ø 150mm

E: 2732mm



L 9303F
L 9303H
2395mm
Ø 150mm
Ø 75mm

L 9304F
L 9304H
2425mm
Ø 150mm
Ø 75mm

E: 2762mm





L 9315F
L 9325H
115×300mm
⌀ 180mm



L 9305F
L 9305H
2395mm
⌀ 180mm
⌀ 105mm



L 9319F
L 9319H
145×280mm
⌀ 180mm



L 9306F
L 9306H
2425mm
⌀ 180mm
⌀ 105mm



L 9316F
L 9326H
245×330mm
⌀ 180mm

E: 2655mm

E: 2685mm

L 9305F
L 9305H
2395mm
⌀ 180mm
⌀ 105mm

L 9306F
L 9306H
2425mm
⌀ 180mm
⌀ 105mm



L 9319F
L 9319H
145×280mm
⌀ 180mm



E: 2785mm



E: 2815mm

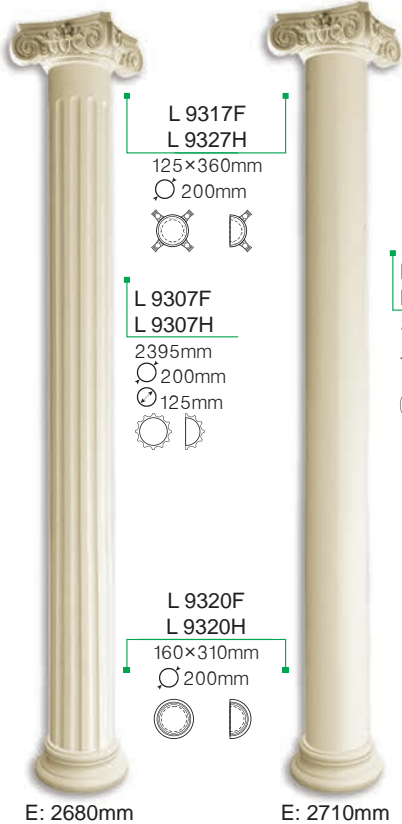

L 9317F
L 9327H
125×360mm
⊙ 200mm



L 9307F
L 9307H
2395mm
⊙ 200mm
⊙ 125mm



L 9320F
L 9320H
160×310mm
⊙ 200mm

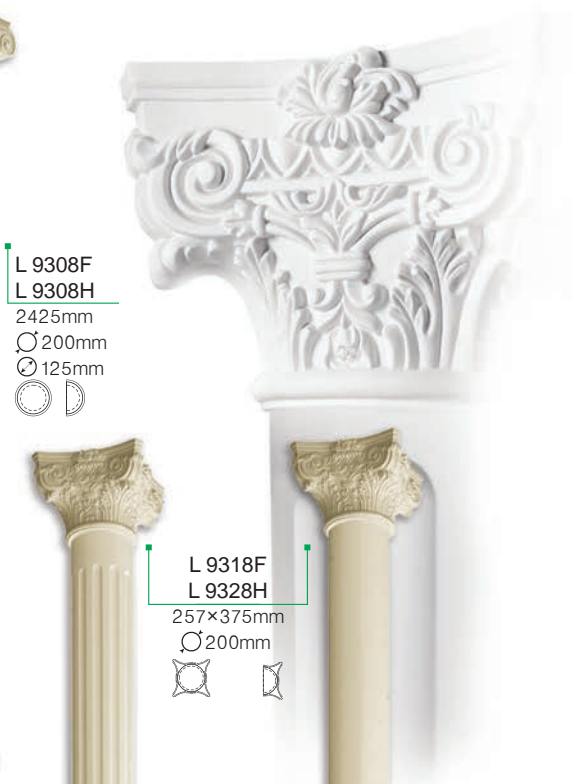

E: 2680mm

E: 2710mm



L 9308F
L 9308H
2425mm
⊙ 200mm
⊙ 125mm

L 9318F
L 9328H
257×375mm
⊙ 200mm

L 9307F
L 9307H
2395mm
⊙ 200mm
⊙ 125mm

L 9308F
L 9308H
2425mm
⊙ 200mm
⊙ 125mm

E: 2812mm

E: 2842mm



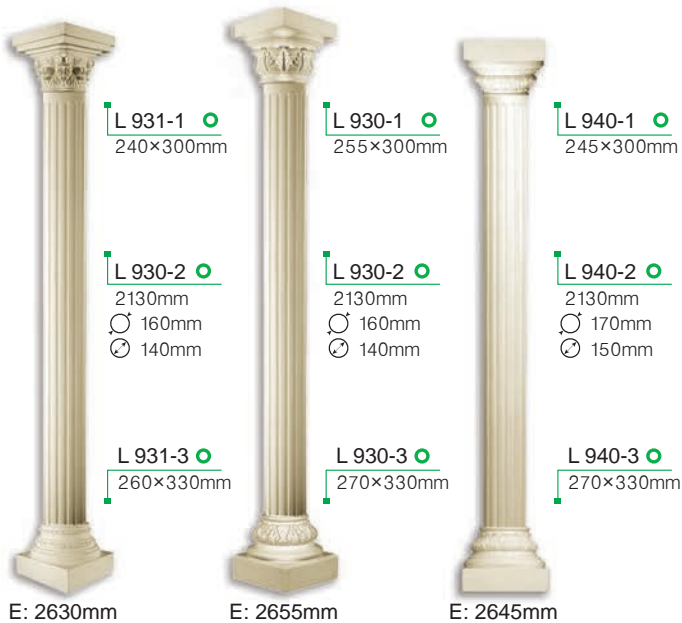

Укороченная колонна может быть использована как пьедестал для статуй, ваз и других декоративных деталей интерьера.

L 905

Высота: 705mm
Капитель: 260mm
Диаметр тела: 220mm
Основание: 300mm

L 925

Высота: 760mm
Капитель: 347mm
Диаметр тела: 320mm
Основание: 347mm

L 920

Высота: 762mm
Капитель: 300mm
Диаметр тела: 160mm
Основание: 300mm

L 919

Высота: 762mm
Капитель: 303mm
Диаметр тела: 160mm
Основание: 300mm

L 926

Высота: 762mm
Капитель: 355mm
Диаметр тела: 220mm
Основание: 360mm

L 924

Высота: 790mm
Капитель: 350mm
Диаметр тела: 220mm
Основание: 300mm

L 915

Высота: 908mm
Капитель: 250mm
Диаметр тела: 120mm
Основание: 250mm

L 904

Высота: 1050mm
Капитель: 310mm
Диаметр тела: 220mm
Основание: 322mm

L 914

Высота: 1170mm
Капитель: 330mm
Диаметр тела: 200mm
Основание: 310mm

Эта коллекция избавит вас от однообразной обстановки. У вас есть выбор средств для создания, желаемой атмосферы. Обычно эти элементы применяются на участках с фонтанами, источниками.

Имитация декоративного оформления из камня.



W 8011A

280×240×37mm



W 8011B

285×240×35mm



W 8011C

285×257×35mm



W 8011D

285×245×35mm



D 597

550×550×16mm



W 8010A

280×240×35mm



W 8010B

285×240×35mm



W 8010C

277×238×37mm



W 8010D

277×238×37mm



D 598

220×550×16mm



W 801

575×685×30mm

W 8044

Ø195



W 8049

369×1195×50mm



W 8048

307×994×21mm



M 901

780×1000×39mm



W 705
80×300×12mm



W 690
390×535×30mm



W 8037
190×165×35mm



W 8038L
165×298×30mm



W 8038R
165×298×30mm



W 8028
130×330×30mm



W 8039
180×165×35mm



W 8038L
165×298×30mm



W 8038R
165×298×30mm



W 8025
125×550×37mm

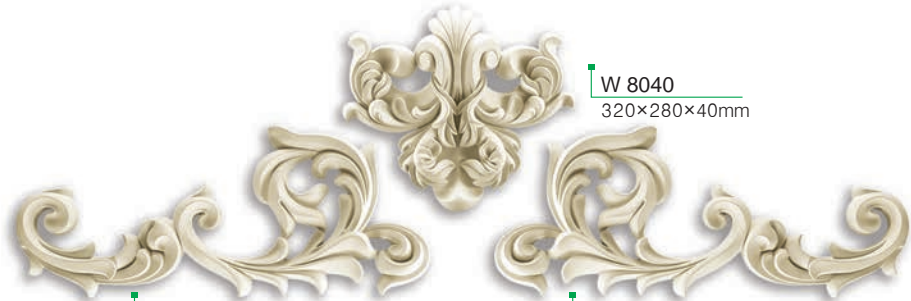

W 8040
320×280×40mm



W 8041L
287×686×47mm



W 8041R
287×686×47mm



W 8021
155×290×25mm



W 703
220×410×35mm



W 988
130×126×18mm



W 8035
190×609×55mm



W 8019
230×387×35mm



W 984
160×117×30mm



W 8027
175×353×52mm



W 8033
170×100×25mm



W 986
125×210×40mm



W 8026S
140×230×30mm



W 8005
81×62×10mm



W 985
176×155×26mm



W 983
180×200×14mm



W 708
185×240×25mm



W 8029
225×416×52mm



W 8029S
160×270×35mm



W 707L
190×415×30mm



W 707R
190×415×30mm



W 8034
225×828×42mm



W 8022
360×795×50mm



W 8036
320×910×50mm



W 706
270×425×20mm



W 762
240×480×16mm



W 8023L
332×80×23mm

W 8023R
332×80×23mm



W 8054
383×365×185mm



W 8055
376×365×185mm



○ W 805
1400×720×90mm



W 804
738×525×35mm



W 803
790×650×65mm



W 802
810×650×50mm

Обрамление дверных проемов



Данные украшения используются как обрамление дверных проемов. Это придает дверям классическое изящество. Лепные украшения предоставляют гибкость в подборе и комбинировании желаемых предпочтений. Они также используются для подчеркивания рельефа двери.





Обрамление дверных проемов



D 581 195×1250×35mm



D 581 + D 586



D 581 + D 583



D 581 + D 584 + D 600×2



D 581 + D 588×2



D 597
550×550×16mm



D 598
220×550×16mm



D 600
110×110×28mm



D 588
95×95×50mm



D 590
95×95×40mm

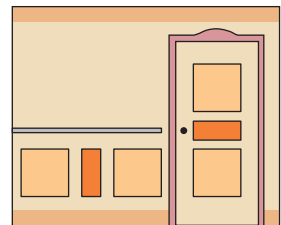
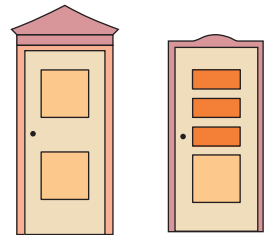

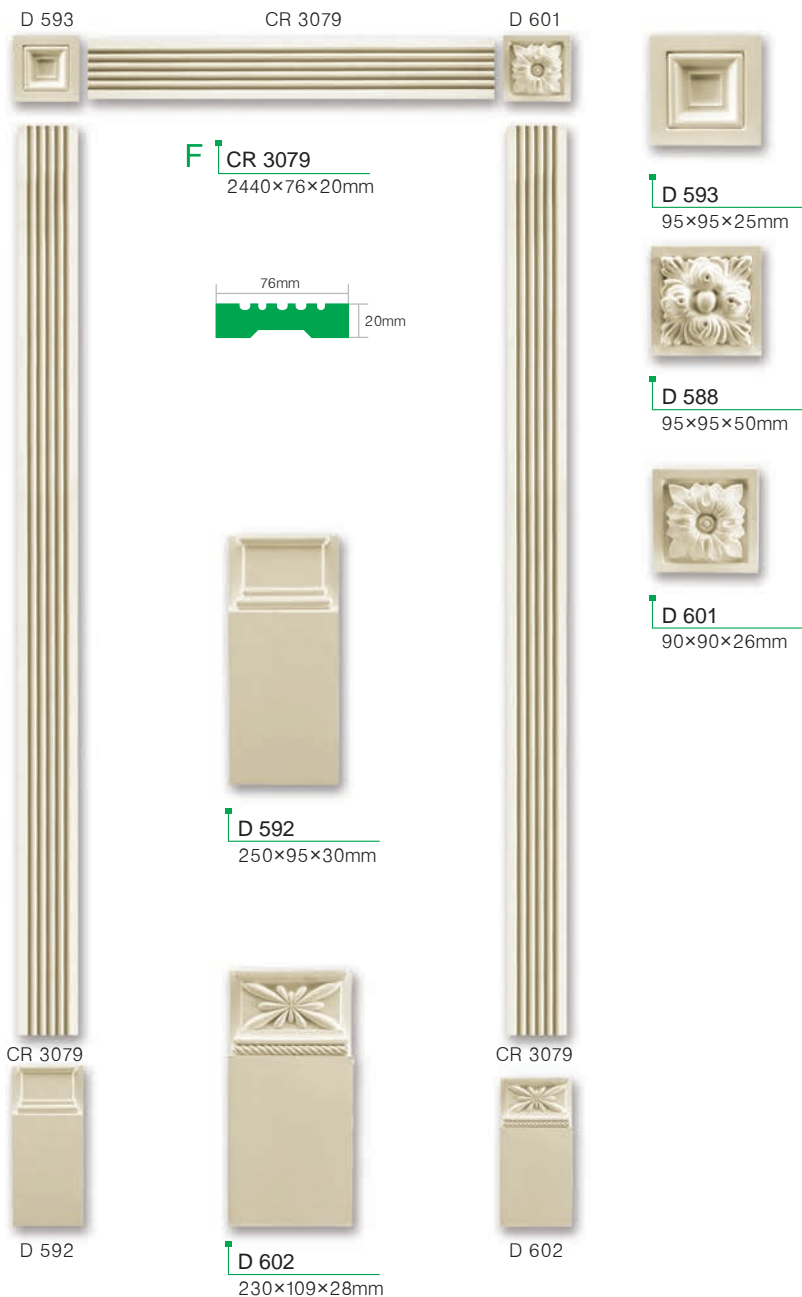

Ниши используются как встроенный элемент декора наружной и внутренней части дома. Пространство внутри ниши может быть заполнено бюстами, статуэтками, цветочными композициями, а также подсвечено.



N 732

A: 280mm
B: 260mm
C: 180mm
D: 380mm
E: 500mm
F: 85mm
G: 85mm
H: 50mm
I: 68mm



N 734

A: 640mm
B: 570mm
C: 450mm
D: 1015mm
E: 1320mm
F: 205mm
G: 335mm
H: 170mm
I: 330mm



N 731

A: 450mm
B: 440mm
C: 360mm
D: 645mm
E: 765mm
F: 85mm
G: 200mm
H: 125mm
I: 190mm



○ N 736

- A: 690mm
- B: 660mm
- C: 520mm
- D: 970mm
- E: 1145mm
- F: 120mm
- G: 280mm
- H: 210mm
- I: 275mm

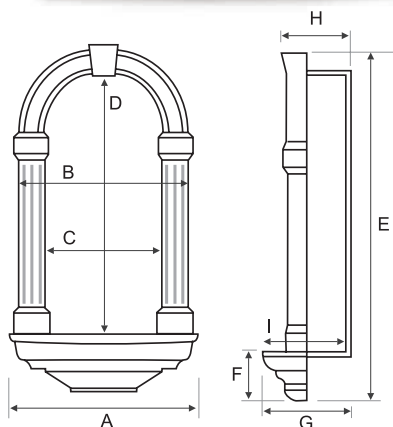

○ N 738

- A: 555mm
- B: 515mm
- C: 375mm
- D: 740mm
- E: 1000mm
- F: 190mm
- G: 242mm
- H: 145mm
- I: 223mm



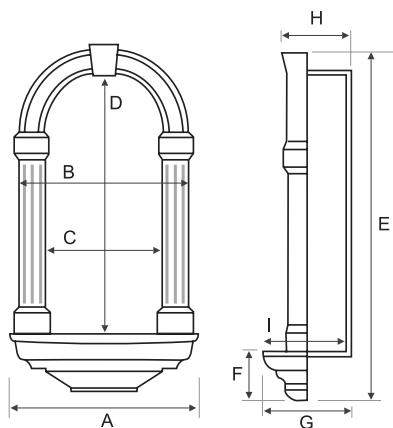

N 733-A

- A: 420mm
- B: 375mm
- C: 265mm
- D: 560mm
- E: 765mm
- F: 135mm
- G: 200mm
- H: 125mm
- I: 190mm

N 733

- A: 420mm
- B: 375mm
- C: 265mm
- D: 560mm
- E: 765mm
- F: 135mm
- G: 105mm
- H: 30mm

Потолочные купола разработаны для преобразования потолка, придавая приятную иллюзию глубины и объема. Изготовлены из уплотненного полиуретана и пластика.

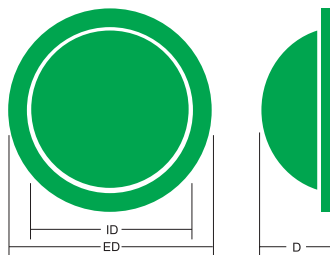

○ **DM 3501**
 ED: 1230mm
 ID: 980mm
 D: 230mm



○ **DM 3502**
 ED: 1230mm
 ID: 1080mm
 D: 200mm



○ **DM 3503**
 ED: 720mm
 ID: 570mm
 D: 125mm



DM 3504
ED: 1130mm
ID: 995mm
D: 215mm



DM 3505
ED: 1448mm
ID: 1220mm
D: 272mm



DM 3506
ED: 1225mm
ID: 1065mm
D: 215mm



DM 3507
ED: 1168mm
ID: 1005mm
D: 238mm



DM 3508
ED: 1130mm
ID: 930mm
D: 250mm



DM 3509
ED: 1530mm
ID: 1430mm
D: 90mm



DM 3510

ED: 950mm

ID: 820mm

D: 50mm



DM 3512

ED: 2020mm

ID: 1760mm

D: 190mm



DM 3513

ED: 2020mm

ID: 1760mm

D: 420mm

Оглавление

Карнизы с гладким профилем

P 132		8
P 133	F	8
P 134	F	5
P 135	F	7
P 136	F	6
P 149		9
P 201	F	6
P 202	F	7
P 203	F	7
P 205	F	5
P 207	F	6
P 208	F	5
P 210	F	5
P 212	F	5
P 214	F	5
P 219	F	5
P 220	F	5
P 221	F	4
P 222	F	4
P 223	F	7
P 224	F	4
P 232	F	6
P 880	F	9
P 881	F	5
P 882	F	6
P 883	F	5
P 884	F	7
P 885	F	7
P 886	F	4
P 887	F	6
P 888	F	9
P 2001	F	6
P 2002	F	4
P 2003	F	4
P 2004	F	8
P 2005	F	7
P 2006	F	8
P 2007	F	5
P 2008	F	7
P 2009	F	5
P 2010	F	4
P 2011	F	8
P 2012	F	4
P 2016	F	7
P 2024	F	9
P 2026	F	9
P 2031	F	9
P 2032	F	8
P 2048	F	7
P 2055	F	7
P 2056	F	6
P 2057	F	4
P 2072	F	7
P 2076	F	6
P 2119	F	4

Карнизы с орнаментом

C 101		14
C 102		14
C 104	F	13
C 109	F	14
C 110	F	14
C 117		17
C 118	F	14
C 119	F	14
C 121	F	14
C 122	F	14
C 123	F	14
C 124	F	14
C 125	F	14
C 126	F	15
C 127		14
C 128	F	11

C 129	F	10
C 138	F	13
C 140	F	14
C 141	F	11
C 143	F	14
C 144	F	11
C 147	F	10
C 150	F	15
C 152	F	11
C 156		15
C 158		14
C 159		15
C 160	F	12
C 161	F	10
C 173	F	11
C 176	F	11
C 177	F	13
C 204	F	15
C 233	F	14
C 1001	F	11
C 1002	F	12
C 1003	F	10
C 1004	F	13
C 1005	F	10
C 1006	F	14
C 1007	F	12
C 1008	F	10
C 1009	F	12
C 1010	F	12
C 1012	F	15
C 1013	F	12
C 1014	F	11
C 1015	F	13
C 1016	F	10
C 1018	F	14
C 1021	F	14
C 1022	F	15
C 1030	F	12
C 1033	F	14
C 1035	F	13
C 1036	F	13
C 1037	F	14
C 1041	F	10
C 1044	F	11
C 1049	F	15
C 1060	F	15
C 1061	F	14
C 1063	F	14
C 1067	F	13
C 1068	F	13
C 1071	F	13
C 1075	F	15
C 1079	F	11
C 1084	F	11
C 1085	F	10
C 1088	F	13
C 1090	F	10
C 1091	F	18
C 1092	F	18
C 1093	F	18
C 1097	F	13
C 1113	F	11
C 18100	F	12

Молдинги

CR 137	F	24
CR 153	F	23
CR 154	F	22
CR 155	F	23
CR 199	F	23
CR 200	F	25
CR 402	F	22
CR 403	F	23
CR 404	F	22
CR 405	F	21

CR 407	F	19
CR 512	F	24
CR 516	F	23
CR 518	F	20,28
CR 601		21
CR 602	F	22,29
CR 605	F	20,29
CR 607	F	20,29
CR 608	F	25
CR 610	F	20,27
CR 620	F	20,29
CR 622		21
CR 624	F	20,27
CR 632	F	25
CR 636	F	23
CR 638	F	23
CR 639	F	22
CR 642	F	21
CR 644	F	22
CR 646	F	25
CR 681	F	20
CR 683	F	21
CR 685		19
CR 686	F	19
CR 687		20
CR 688	F	21
CR 689	F	21
CR 3001	F	24
CR 3002	F	20
CR 3003	F	19
CR 3006	F	21
CR 3007	F	21,28
CR 3008	F	24
CR 3009	F	24
CR 3010	F	19,28
CR 3017		26,44,49
CR 3018		26,44,49
CR 3019		26,44,49
CR 3020		26,44,49
CR 3022		21
CR 3023		21
CR 3025		20
CR 3034		19
CR 3035	F	19
CR 3043	F	25
CR 3044	F	24
CR 3051	F	24
CR 3054	F	19
CR 3057	F	21
CR 3059		22
CR 3063		19,27
CR 3072	F	20
CR 3073	F	20
CR 3075	F	19
CR 3079	F	22,68
CR 3100	F	19
CR 3227	F	19
CR 3241	F	25
CR 3242	F	24
CR 3243	F	23
CR 3245	F	25
CR 3246	F	25
CR 3247	F	26

Угловые элементы

CF 518A		28
CF 518B		28
CF 602A		29
CF 605A		29
CF 605B		29
CF 607B		29
CF 611		27
CF 612		27
CF 613		27
CF 614		27

CF 620A		29
CF 624A		27
CF 624B		27
CF 3007A		28
CF 3007B		28
CF 3010A		28
CF 3010B		28
CF 3010C		28
CF 3010D		28
CF 3010E		28
CF 3063A		27
CF 3063B		27

Круговые бордюры

LR 166		30
LR 167		30
LR 168		30
LR 689/60		31
LR 689/70		31
LR 689F(L)/60		31
LR 689F(L)/70		31
LR 689F(R)/60		31
LR 689F(R)/70		31
LR 689R/60		31
LR 689R/70		31
LR 3073/50		31
LR 3073/65		31
LR 3073F(L)/50		31
LR 3073F(L)/65		31
LR 3073F(R)/50		31
LR 3073F(R)/65		31
LR 3073R/50		31
LR 3601		30
LR 3602		30

Потолочные розетки

R 120		37
R 301		35
R 302		37
R 303		33
R 304		33
R 305		36
R 306		35
R 307		37
R 308		37
R 309		34
R 310		34
R 311		33
R 312		32
R 313		34
R 314		32
R 316		32
R 317		35
R 318		32
R 335		37
R 336		36
R 337		36
R 338		36
R 345		35
R 347		33
R 348		35
R 349		34
R 350		33
R 361		36
R 371		32
R 4006		36
R 4007		37
R 4012		34
R 4015		32
R 4016		32
R 4017		32
R 4019		34
R 4022		34

